

SAMSUNG

GSM TELEPHONE

GT-E1080

SERVICE *Manual*

GSM TELEPHONE



CONTENTS

1. Safety Precautions
2. Specification
3. Product Function
4. Array course control
5. Exploded View and Parts list
6. MAIN Electrical Parts List
7. Block Diagrams
8. PCB Diagrams
9. Chart of Troubleshooting
10. Reference data
11. Disassembly and Assembly Instructions

**SAMSUNG
ELECTRONICS**



GSPN (Global Service Partner Network)

Country	Web Site
North America	service.samsungportal.com
Latin America	latin.samsungportal.com
CIS	cis.samsungportal.com
Europe	europe.samsungportal.com
China	china.samsungportal.com
Asia	asia.samsungportal.com
Mideast & Africa	mea.samsungportal.com

2. Specification

2-1. GSM General Specification

	GSM850 Phase 1	DCS1800 Phase 1
Freq. Band[MHz] Uplink/Downlink	824.2~848.8 869.2~893.8	1710~1785 1805~1880
ARFCN range	128~251	512~885
Tx/Rx spacing	45MHz	95MHz
Mod. Bit rate/ Bit Period	270.833kbps 3.692us	270.833kbps 3.692us
Time Slot Period/Frame Period	576.9us 4.615ms	576.9us 4.615ms
Modulation	0.3GMSK	0.3GMSK
MS Power	33dBm~5dBm	30dBm~0dBm
Power Class	5pcl ~ 19pcl	0pcl ~ 15pcl
Sensitivity	-102dBm	-100dBm
TDMA Mux	8	8
Cell Radius	35Km	2Km

2-2. GSM Tx Power Class

TX Power control level	GSM850	TX Power control level	DCS1800
5	33±3 dBm	0	30±3 dBm
6	31±3 dBm	1	28±3 dBm
7	29±3 dBm	2	26±3 dBm
8	27±3 dBm	3	24±3 dBm
9	25±3 dBm	4	22±3 dBm
10	23±3 dBm	5	20±3 dBm
11	21±3 dBm	6	18±3 dBm
12	19±3 dBm	7	16±3 dBm
13	17±3 dBm	8	14±3 dBm
14	15±3 dBm	9	12±4 dBm
15	13±3 dBm	10	10±4 dBm
16	11±5 dBm	11	8±4dBm
17	9±5 dBm	12	6±4 dBm
18	7±5 dBm	13	4±4 dBm
19	5±5 dBm	14	2±5 dBm
		15	0±5 dBm

2-3. GSM EDGE TX power class

Only in Master

TX Power control level	GSM900	TX Power control level	DCS1800
8	27±3 dBm	2	26±3 dBm
9	25±3 dBm	3	24±3 dBm
10	23±3 dBm	4	22±3 dBm
11	21±3 dBm	5	20±3 dBm
12	19±3 dBm	6	18±3 dBm
13	17±3 dBm	7	16±3 dBm
14	15±3 dBm	8	12±3 dBm
15	13±3 dBm	9	10±3 dBm
16	11±5 dBm	10	14±3 dBm
17	9±5 dBm	11	12±4 dBm
18	7±5 dBm	12	10±4 dBm
19	5±5 dBm	13	8±4dBm
		14	6±4 dBm
		15	4±4 dBm

3. Operation Instruction and Installation

Main Function

- GSM 850/1800
- 1.43" CSTN
- WAP 2.0 Browser
- SMS, MMS
- 64 Poly Melody
- Noise Cancellatio
- JAVA

4. Array course control

4-1. Software Adjustments



Test Jig (GH99-36900A)



Test Cable (GH39-01160A)



RF Test Cable (GH39-00985A)



Adapter (GH99-38251A)

4-2. Software Downloading

4-2-1. Pre-requisite for Downloading

- Downloader Program([PNX4900 Downloader v1.0 For Lite](#))
- GT-E1080 Mobile Phone
- Data Cable
- JIG BOX
- Test Cable
- Serial Cable
- Binary files

4-2-2. S/W Downloader Program

- Load the binary download program by executing the "[PNX4900 Downloader v1.0 Lite](#)"

1. Select the connected serial port and the rate of speed.

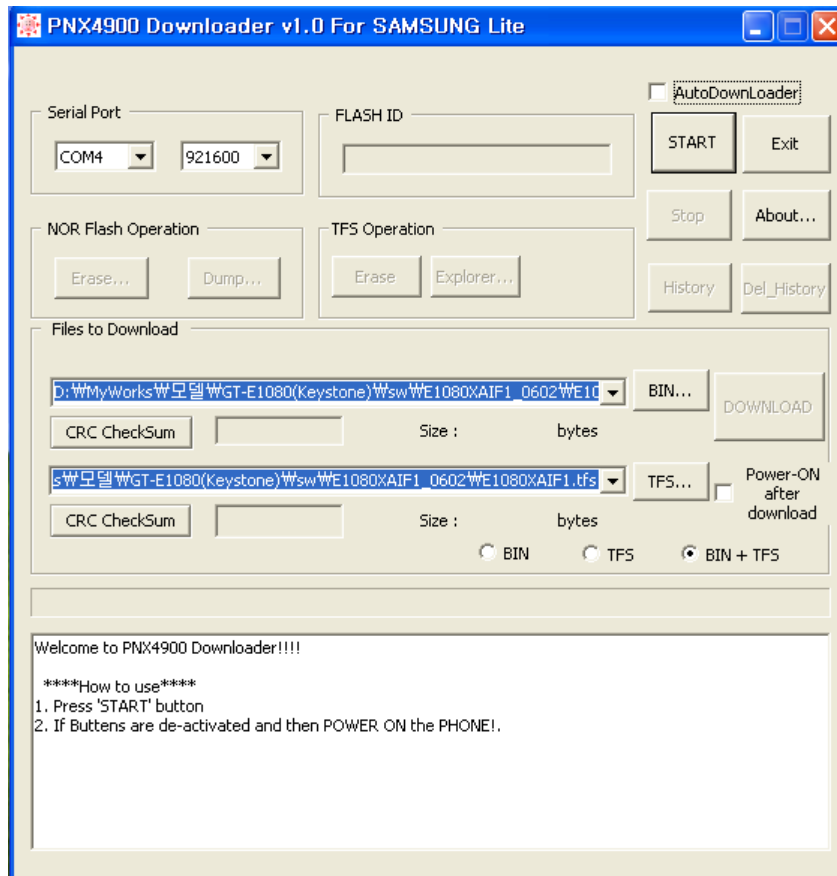

2. Select the Port, Baud Rate and Mode.

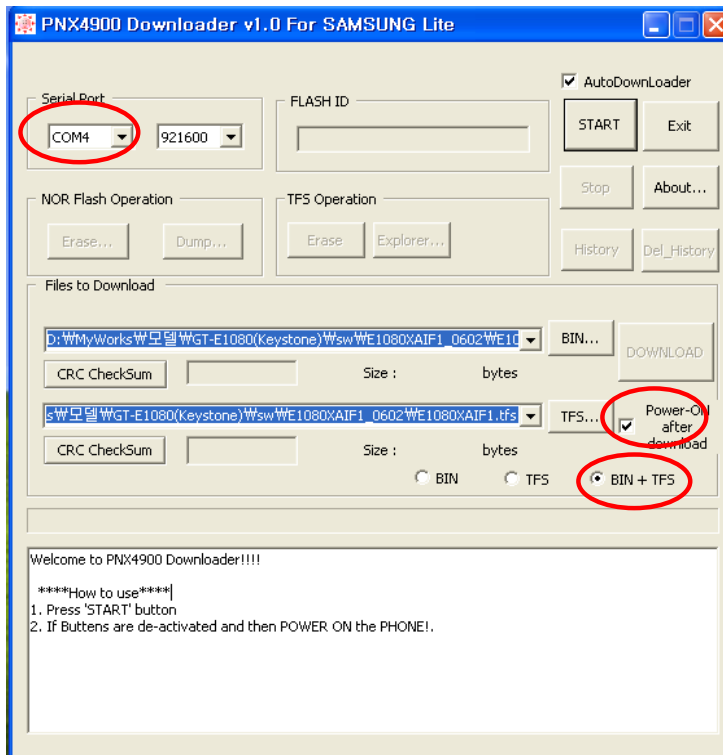

3. Select the START Button, When Complete DL.Bootloader.

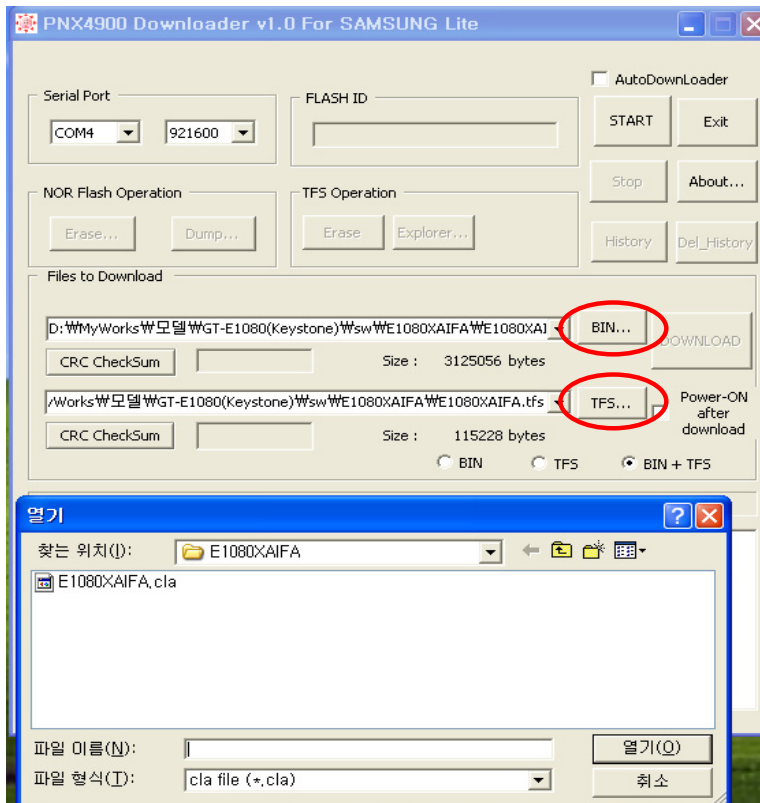

4. 4. Press the "Start" button and connect the Handset, then press "확인".

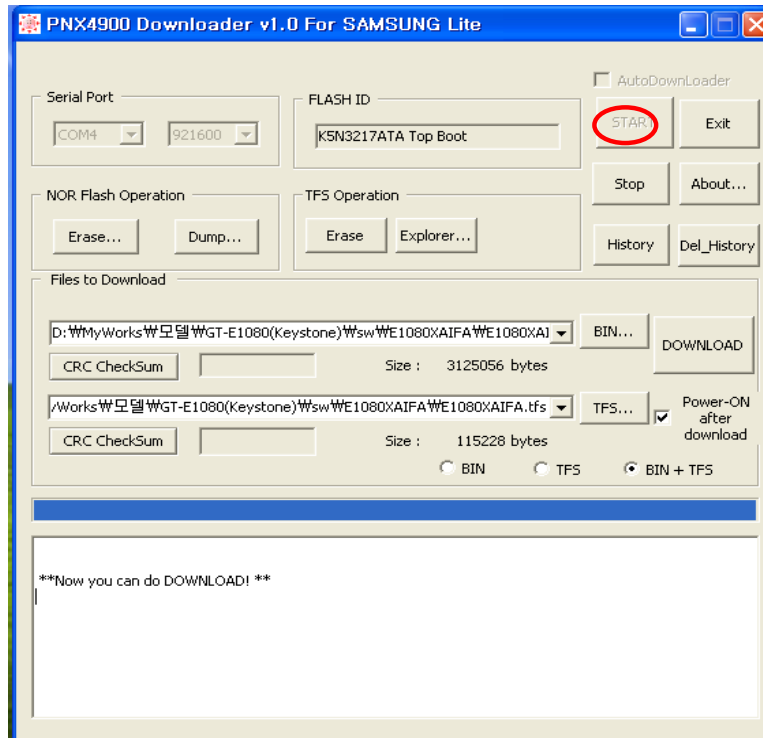

5. Check the All Download & Calset , Click the Download Button,

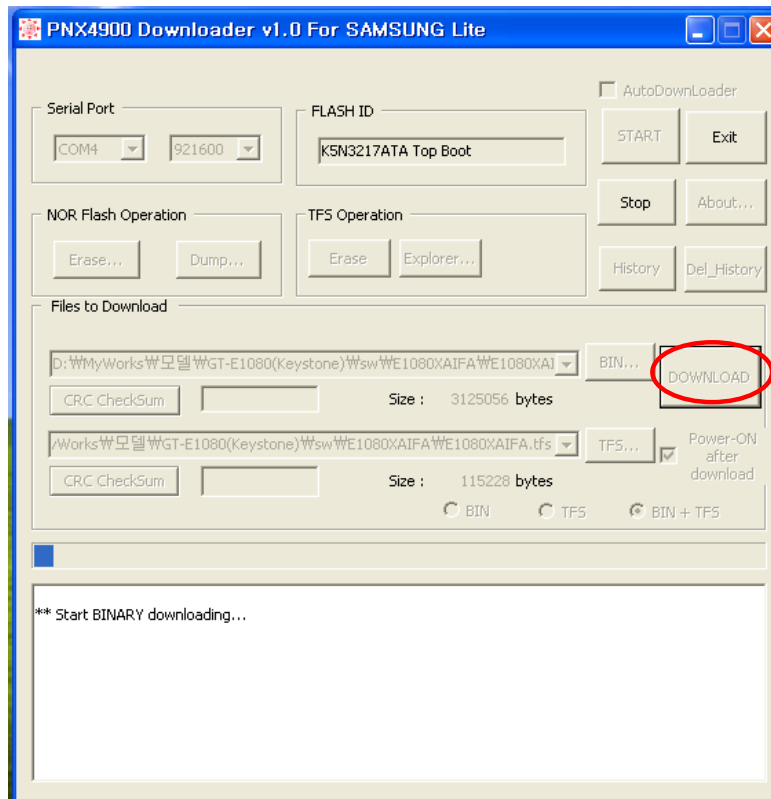

6. When downloading is complete, automatically the small window was showed up.

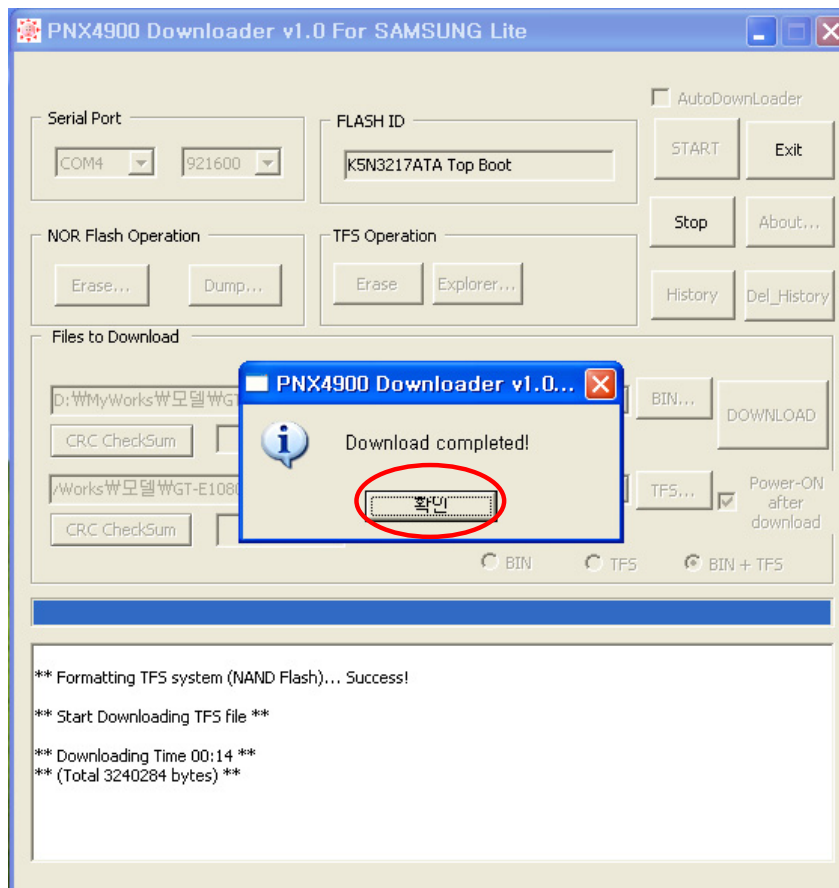

7. Confirm the downloaded version name and etc. :

***#1234#**

Full Reset :

***0206*3855#**

10. Reference data

Reference Abbreviate

- **AAC**: Advanced Audio Coding.
- **AVC** : Advanced Video Coding.
- **BER** : Bit Error Rate
- **BPSK**: Binary Phase Shift Keying
- **CA** : Conditional Access
- **CDM** : Code Division Multiplexing
- **C/I** : Carrier to Interference
- **DMB** : Digital Multimedia Broadcasting
- **EN** : European Standard
- **ES** : Elementary Stream
- **ETSI**: European Telecommunications Standards Institute
- **MPEG**: Moving Picture Experts Group
- **PN** : Pseudo-random Noise
- **PS** : Pilot Symbol
- **QPSK**: Quadrature Phase Shift Keying
- **RS** : Reed-Solomon
- **SI** : Service Information
- **TDM** : Time Division Multiplexing
- **TS** : Transport Stream

1. Safety Precautions

1-1. Repair Precaution

- Repair in Shield Box, during detailed tuning. Take specially care of tuning or test, because specipcty of cellular phone is sensitive for surrounding interference(RF noise).
- Be careful to use a kind of magnetic object or tool, because performance of parts is damaged by the influence of magnetic force.
- Surely use a standard screwdriver when you disassemble this product, otherwise screw will be worn away.
- Use a thicken twisted wire when you measure level.
A thicken twisted wire has low resistance, therefore error of measurement is few.
- Repair after separate Test Pack and Set because for short danger (for example an overcurrent and furious flames of parts etc) when you repair board in condition of connecting Test Pack and tuning on.
- Take specially care of soldering, because Land of PCB is small and weak in heat.
- Surely tune on/off while using AC power plug, because a repair of battery charger is dangerous when tuning ON/OFF PBA and Connector after disassembling charger.
- Don't use as you pleases after change other material than replacement registered on SEC System. Otherwise engineer in charge isn't charged with problem that you don't keep this rules.

1-2. ESD(Electrostatically Sensitive Devices) Precaution

Several semiconductor may be damaged easily by static electricity. Such parts are called by ESD (Electrostatically Sensitive Devices), for example IC,BGA chip etc. Read Precaution below.

You can prevent from ESD damage by static electricity.

- Remove static electricity remained your body before you touch semiconductor or parts with semiconductor. There are ways that you touch an earthed place or wear static electricity prevention string on wrist.
- Use earthed soldering steel when you connect or disconnect ESD.
- Use soldering removing tool to break static electricity. , otherwise ESD will be damaged by static electricity.
- Don't unpack until you set up ESD on product. Because most of ESD are packed by box and aluminum plate to have conductive power,they are prevented from static electricity.
- You must maintain electric contact between ESD and place due to be set up until ESD is connected completely to the proper place or a circuit board.

5. Exploded View and Parts List

5-1. Cellular phone Exploded View

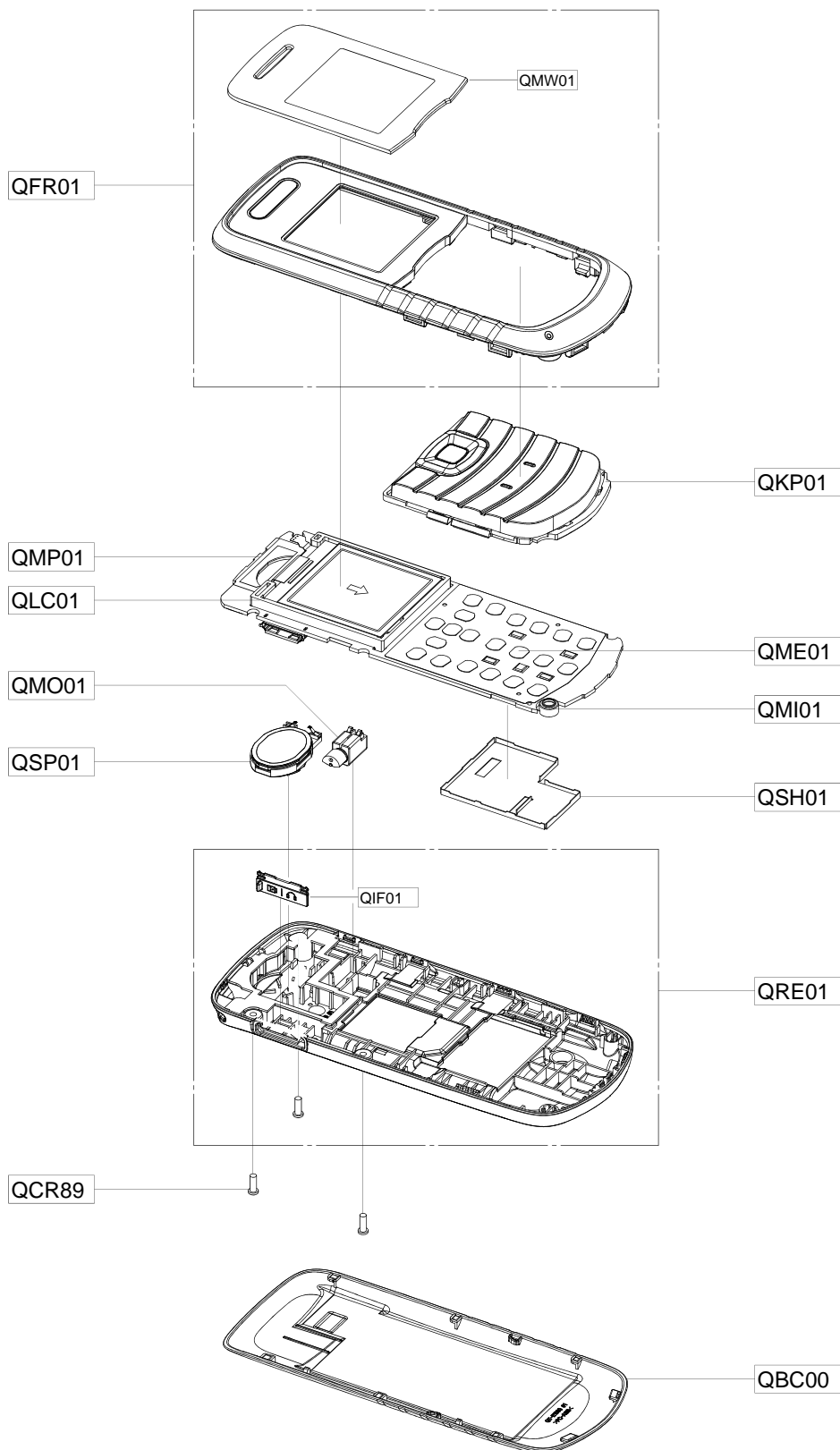

- This Document can not be used without Samsung's authorization -

5-2. Cellular phone Parts list : GT-E1080ZKAXEN

Design LOC	Description	SEC CODE
QBC00	ASSY COVER-BATT	GH98-13873A
QCR89	SCREW-TAPPING	6002-001428
QFR01	ASSY CASE-FRONT	GH98-13872A
QIF01	PMO COVER-IF	GH72-55325A
QKP01	RMO KEY-ALL	GH73-13125A
QLC01	ASSY LCD-1.43" STD CSTN PNL	GH96-04008A
QME01	DOME SHEET-MAIN 22 KEY(GT-E1080)	GH59-07942A
QMI01	MICROPHONE-ASSY-GT_E1080	GH30-00607A
QMO01	MOTOR DC-SCH-S369	GH31-00392A
QMP01	ASSY PBA MAIN-GT_E1080	GH92-06185A
QMW01	PCT WINDOW-MAIN	GH72-54917A
QRE01	ASSY CASE-REAR	GH98-13871A
QSH01	ICT SHIELD-CAN	GH70-05509A
QSP01	SPEAKER	3001-002509

6. MAIN Electrical Parts List

SEC CODE	Design LOC	Description
0401-001110	D200	DIODE-SWITCHING
0401-001110	D201	DIODE-SWITCHING
0403-001547	ZD200	DIODE-ZENER
0406-001286	ZD301	DIODE-TVS
0406-001286	ZD302	DIODE-TVS
0406-001288	D301	DIODE-TVS
0406-001288	D302	DIODE-TVS
0406-001288	D303	DIODE-TVS
0406-001288	D304	DIODE-TVS
0601-002070	LED301	LED
0601-002070	LED302	LED
0601-002070	LED303	LED
0601-002070	LED304	LED
1003-001440	TR100	IC
1108-000239	UME200	MEMORY
1203-005512	U302	IC
1203-005686	U103	IC
1205-003679	UCP201	IC
1404-001221	TH200	THERMISTOR
2007-000139	R301	R-CHIP
2007-000141	R300	R-CHIP
2007-000141	R306	R-CHIP
2007-000141	R312	R-CHIP
2007-000144	R208	R-CHIP
2007-000148	R200	R-CHIP
2007-000148	R201	R-CHIP
2007-000148	R217	R-CHIP
2007-000151	R109	R-CHIP
2007-000162	R110	R-CHIP
2007-000162	R209	R-CHIP
2007-000172	R207	R-CHIP
2007-000172	R303	R-CHIP
2007-000172	R304	R-CHIP
2007-000172	R305	R-CHIP
2007-000172	R307	R-CHIP
2007-000172	R308	R-CHIP

Main Electrical Parts List

SEC CODE	Design LOC	Description
2007-000173	R309	R-CHIP
2007-000173	R310	R-CHIP
2007-000174	R311	R-CHIP
2007-001301	R206	R-CHIP
2007-001333	R210	R-CHIP
2007-003025	R108	R-CHIP
2007-008500	R203	R-CHIP
2203-000386	C220	C-CERAMIC
2203-000386	C323	C-CERAMIC
2203-000425	C225	C-CERAMIC
2203-000425	C228	C-CERAMIC
2203-000679	C303	C-CERAMIC
2203-000696	C122	C-CERAMIC
2203-000812	C115	C-CERAMIC
2203-000812	C120	C-CERAMIC
2203-000812	C121	C-CERAMIC
2203-000812	C229	C-CERAMIC
2203-000812	U308	C-CERAMIC
2203-000812	U309	C-CERAMIC
2203-001153	C328	C-CERAMIC
2203-001153	U310	C-CERAMIC
2203-001385	C118	C-CERAMIC
2203-001385	C119	C-CERAMIC
2203-002709	C209	C-CERAMIC
2203-002709	C210	C-CERAMIC
2203-002709	C230	C-CERAMIC
2203-005057	C112	C-CERAMIC
2203-005057	L113	C-CERAMIC
2203-005281	C114	C-CERAMIC
2203-005281	C116	C-CERAMIC
2203-005482	C231	C-CERAMIC
2203-005482	C301	C-CERAMIC
2203-005482	C302	C-CERAMIC
2203-005482	C321	C-CERAMIC
2203-005482	C325	C-CERAMIC
2203-006048	C211	C-CERAMIC

SEC CODE	Design LOC	Description
2203-006048	C212	C-CERAMIC
2203-006048	C215	C-CERAMIC
2203-006208	C201	C-CERAMIC
2203-006208	C202	C-CERAMIC
2203-006348	C223	C-CERAMIC
2203-006399	C200	C-CERAMIC
2203-006399	C203	C-CERAMIC
2203-006399	C204	C-CERAMIC
2203-006399	C205	C-CERAMIC
2203-006399	C206	C-CERAMIC
2203-006399	C214	C-CERAMIC
2203-006399	C314	C-CERAMIC
2203-006399	C315	C-CERAMIC
2203-006562	C111	C-CERAMIC
2203-006562	C312	C-CERAMIC
2203-006562	C313	C-CERAMIC
2203-006824	C207	C-CERAMIC
2203-006824	C208	C-CERAMIC
2203-006824	C227	C-CERAMIC
2203-006841	C222	C-CERAMIC
2203-006841	C226	C-CERAMIC
2203-007270	C308	C-CERAMIC
2203-007279	C109	C-CERAMIC
2404-001377	C322	C-CERAMIC
2703-001733	L111	INDUCTOR
2703-002170	L109	INDUCTOR
2703-002170	L114	INDUCTOR
2703-002176	C117	INDUCTOR
2703-002201	L302	INDUCTOR
2703-002201	L303	INDUCTOR
2703-002201	L304	INDUCTOR
2703-002201	L305	INDUCTOR
2703-002201	L306	INDUCTOR
2703-002201	L307	INDUCTOR
2703-002201	L308	INDUCTOR
2703-002201	L309	INDUCTOR

SEC CODE	Design LOC	INDUCTORDescription
2703-002203	L103	INDUCTOR
2703-002204	L110	INDUCTOR
2703-002367	C110	INDUCTOR
2703-003184	L201	INDUCTOR
2801-004353	OSC200	CRYSTAL-UNIT
2801-004805	OSC201	CRYSTAL-UNIT
2904-001879	F100	FILTER-SAW
3301-001158	L200	CORE-FERRITE BEAD
3705-001503	RFS100	CONNECTOR-COAXIAL
3709-001488	SIM200	CONNECTOR-CARD EDGE
3710-002683	IFC300	CONNECTOR-SOCKET
3711-006808	BTC200	CONNECTOR-HEADER
GH70-03276A	SC100	ONBOARD-CLIP-4
GH70-03276A	SC101	ONBOARD-CLIP-4
GH70-03276A	SC102	ONBOARD-CLIP-4
GH70-03276A	SC103	ONBOARD-CLIP-4
GH70-03276A	SC104	ONBOARD-CLIP-4
GH70-03276A	SC105	ONBOARD-CLIP-4
GH70-03276A	SC106	ONBOARD-CLIP-4
GH70-03276A	SC107	ONBOARD-CLIP-4
GH70-03276A	SC108	ONBOARD-CLIP-4
GH70-03276A	SC109	ONBOARD-CLIP-4
GH80-03320A	L310	PB-SHORT-1005
GH80-03320A	R313	PB-SHORT-1005
GH80-03321A	R216	PB-SHORT-0603
1201-002931	PAM100	RF7168SR
1203-005957	U200	BQ24352

Please consult the GSPN website (Samsung Portal) for the most recent version of the product's part list.

9. Flow Chart of Troubleshooting

9-1. Power On

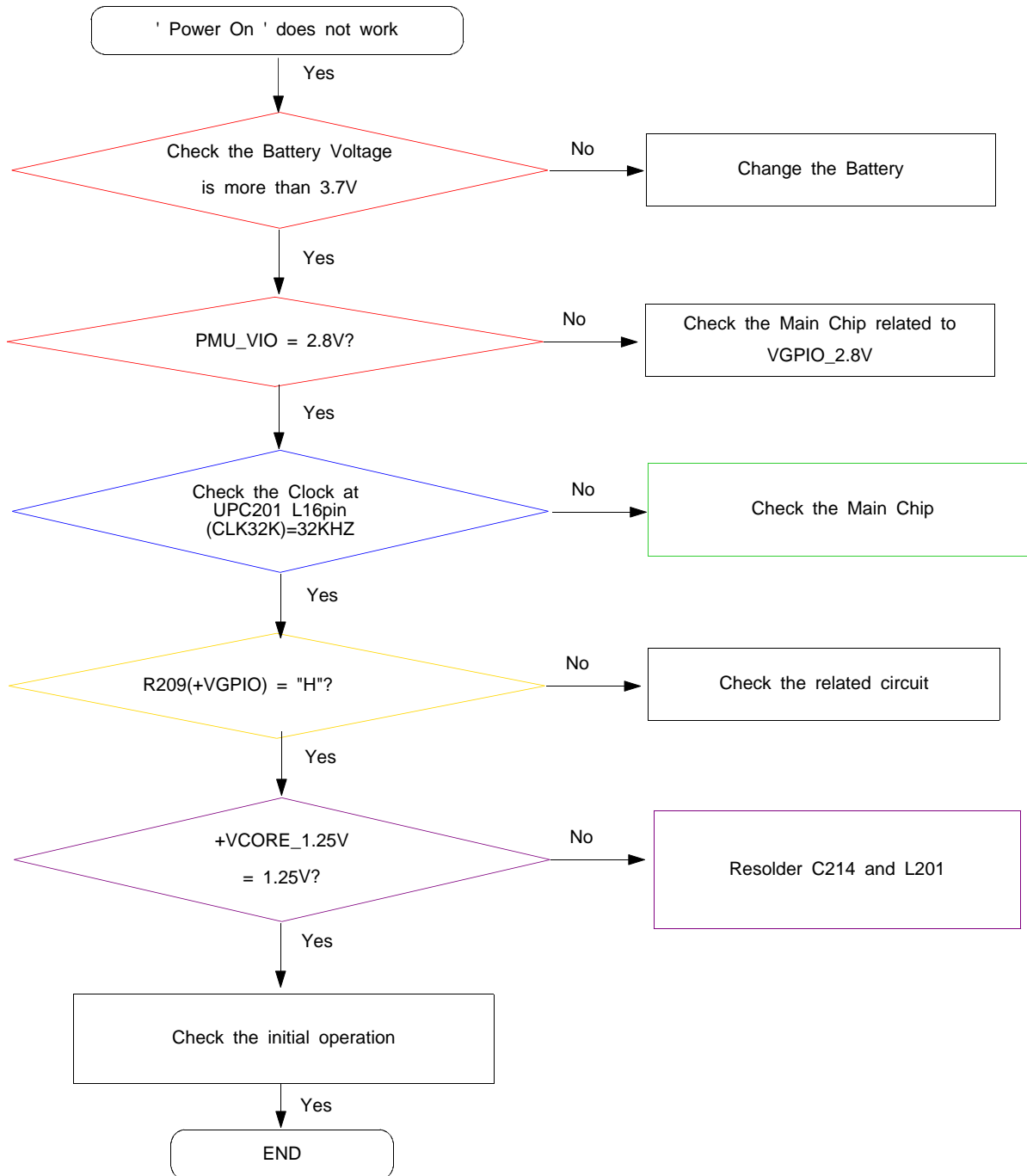

Flow Chart of Troubleshooting

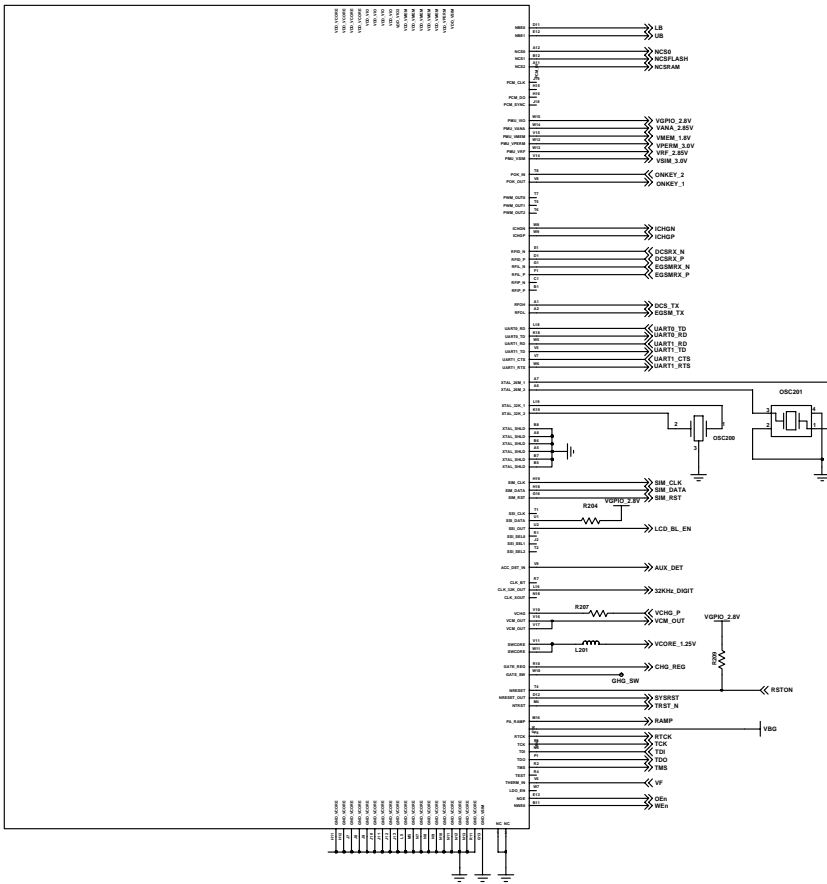
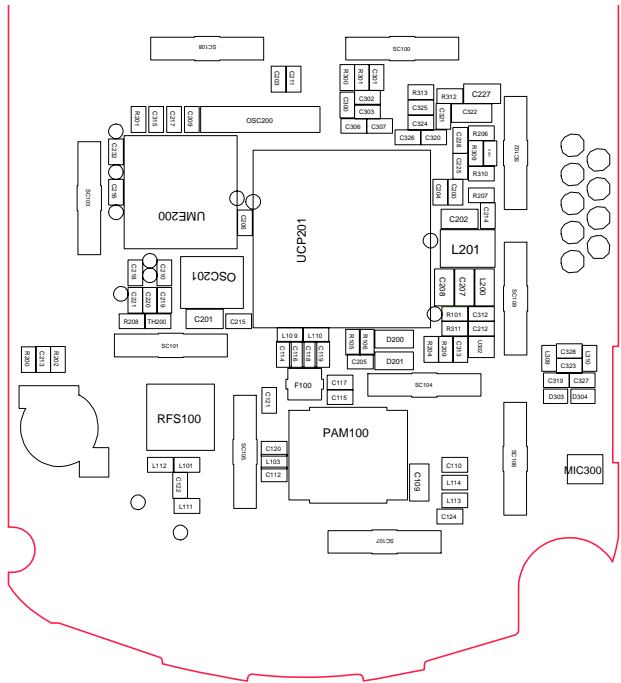

9-2. Initial

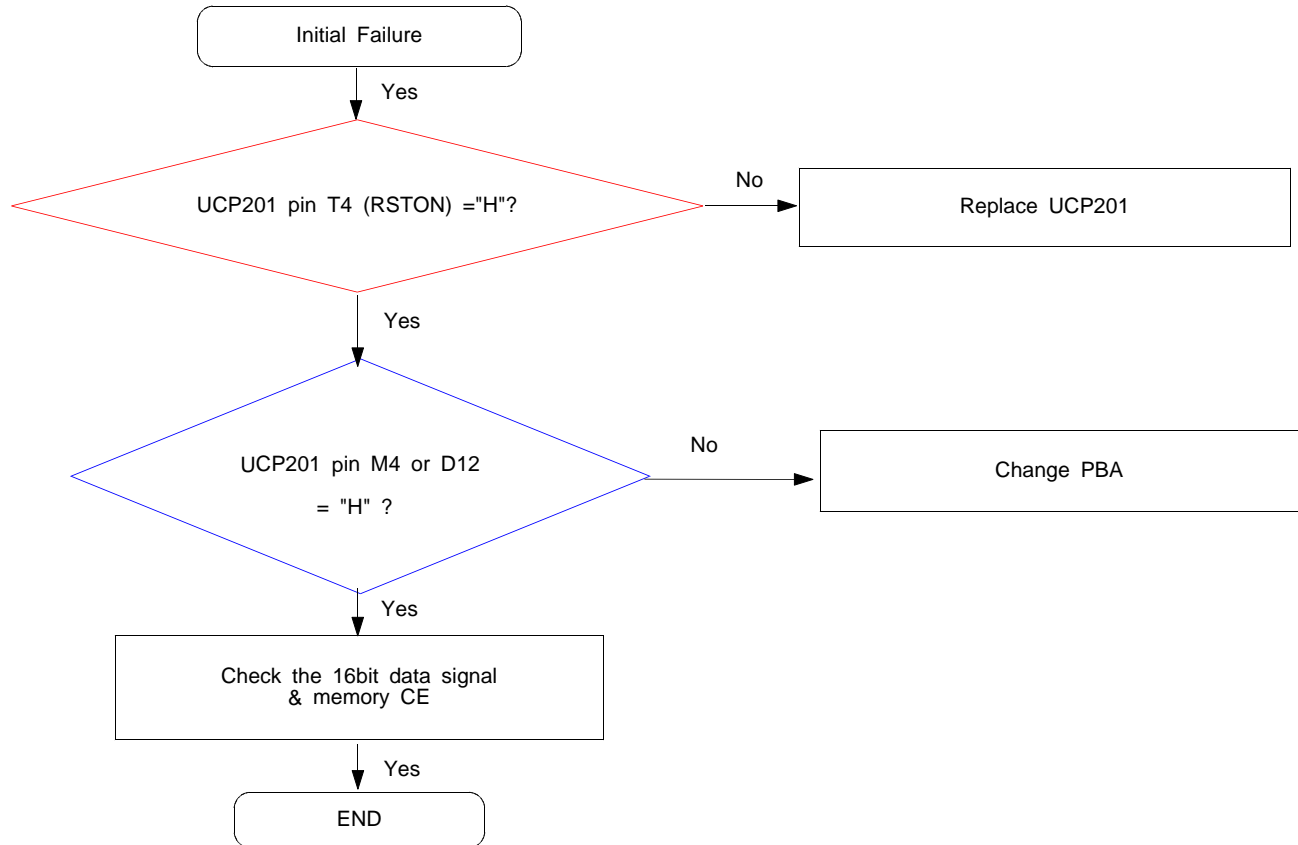

Flow Chart of Troubleshooting

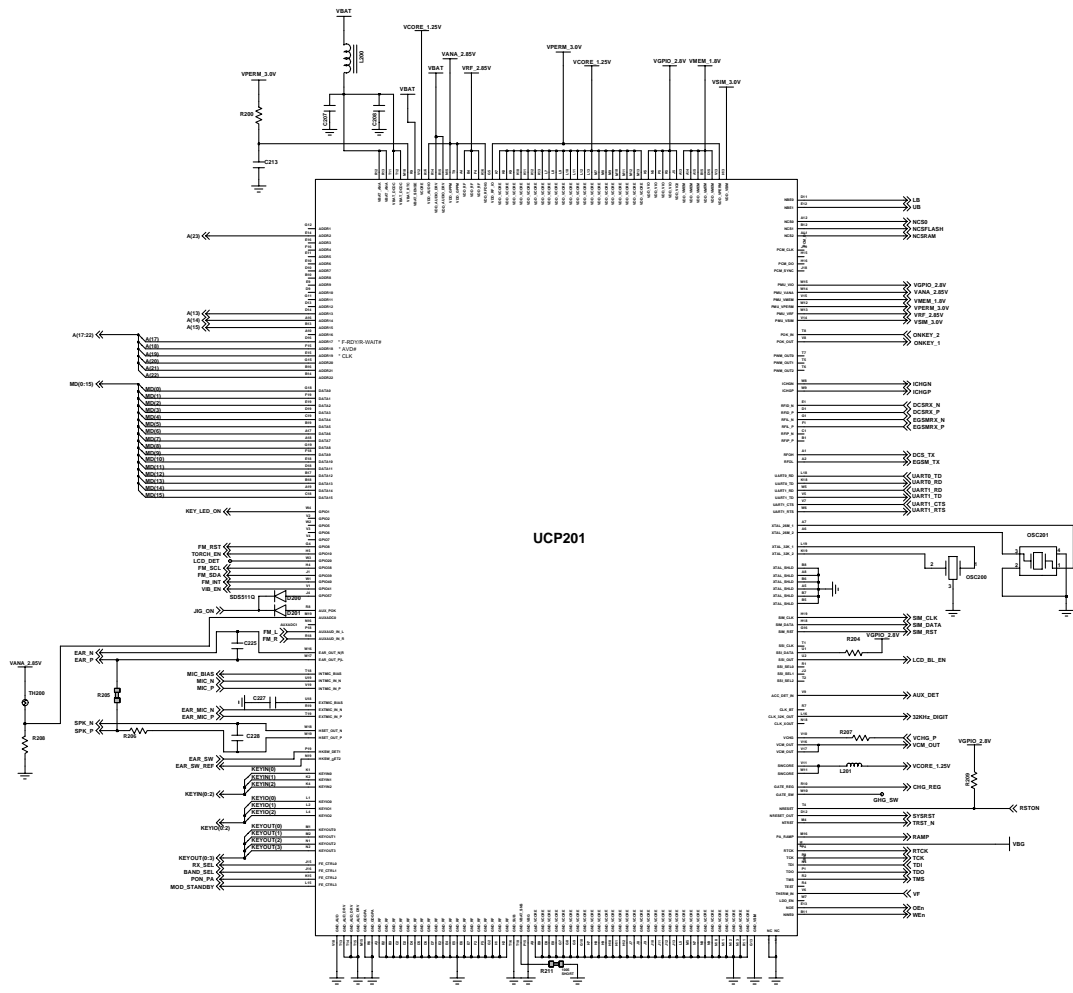
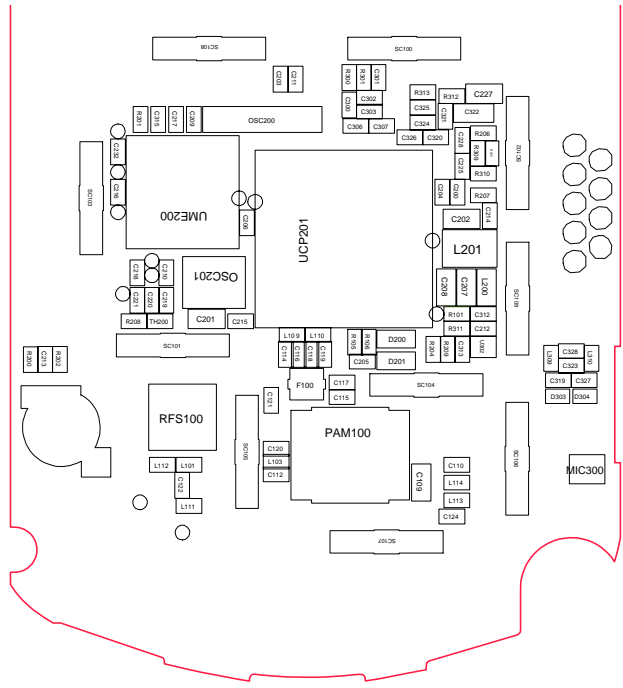

9-3. Charging Part

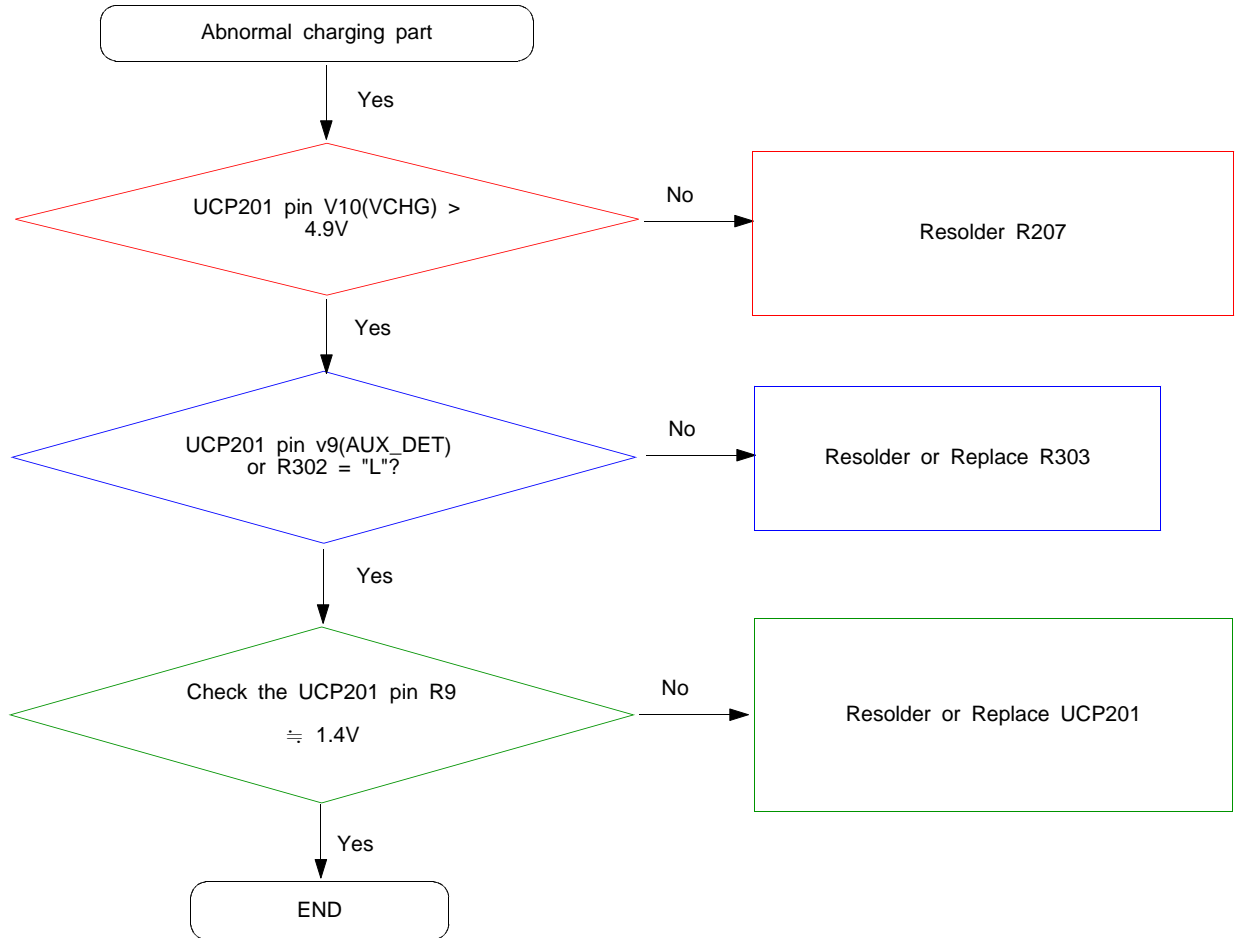

Flow Chart of Troubleshooting

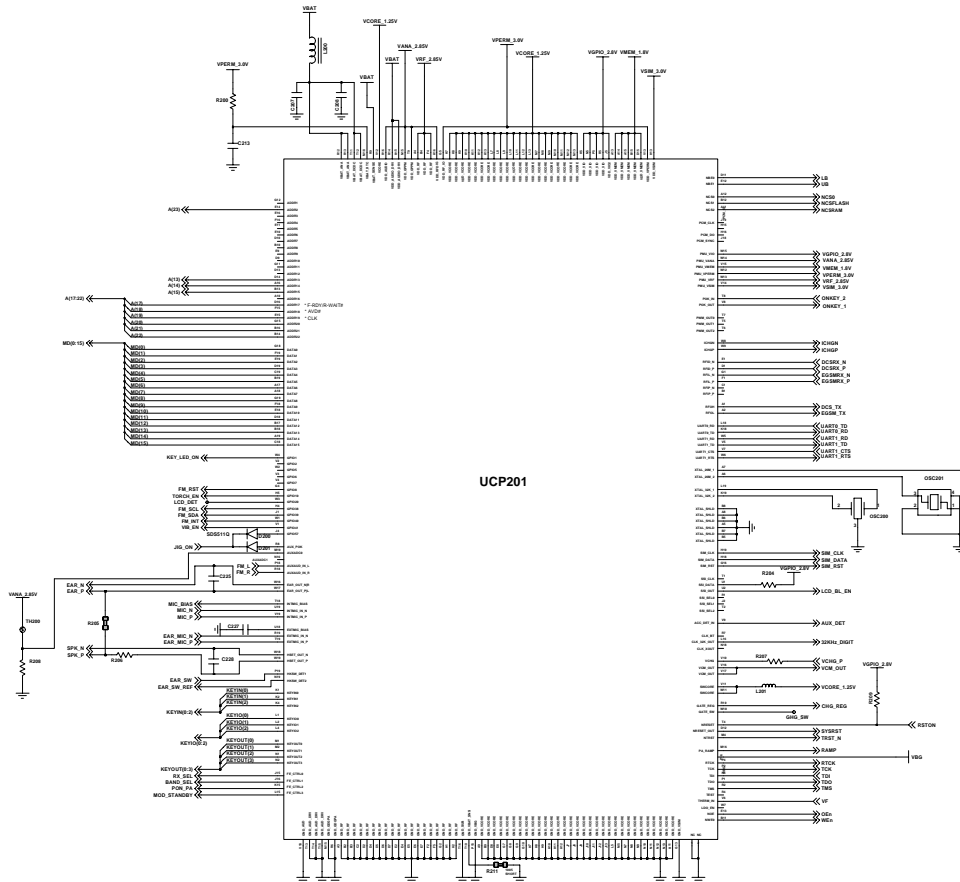
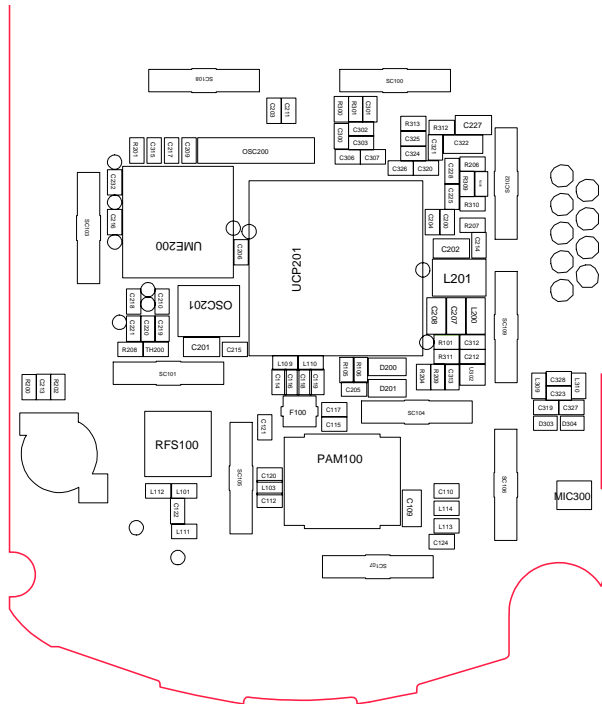

9-4. Sim Part

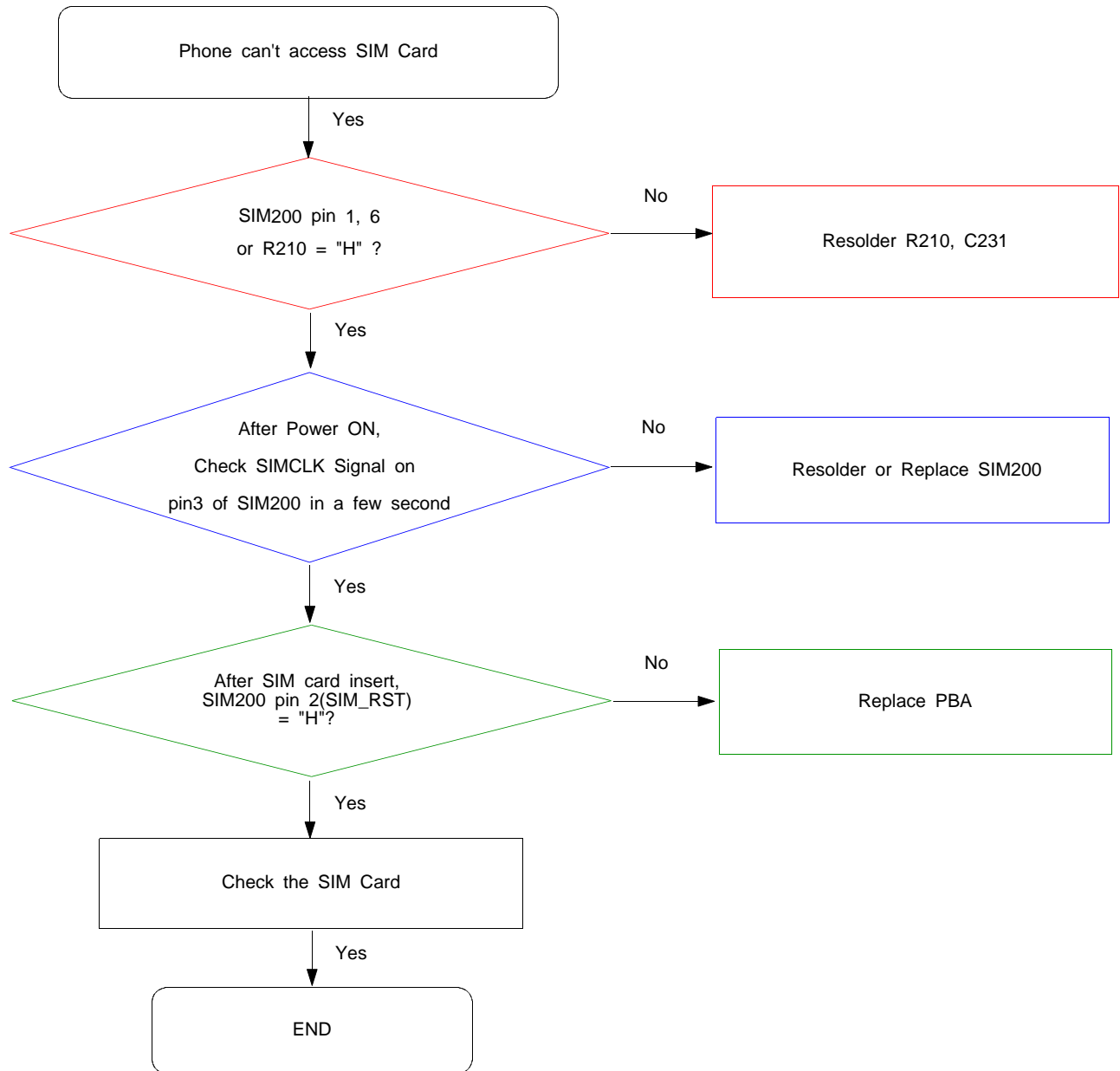

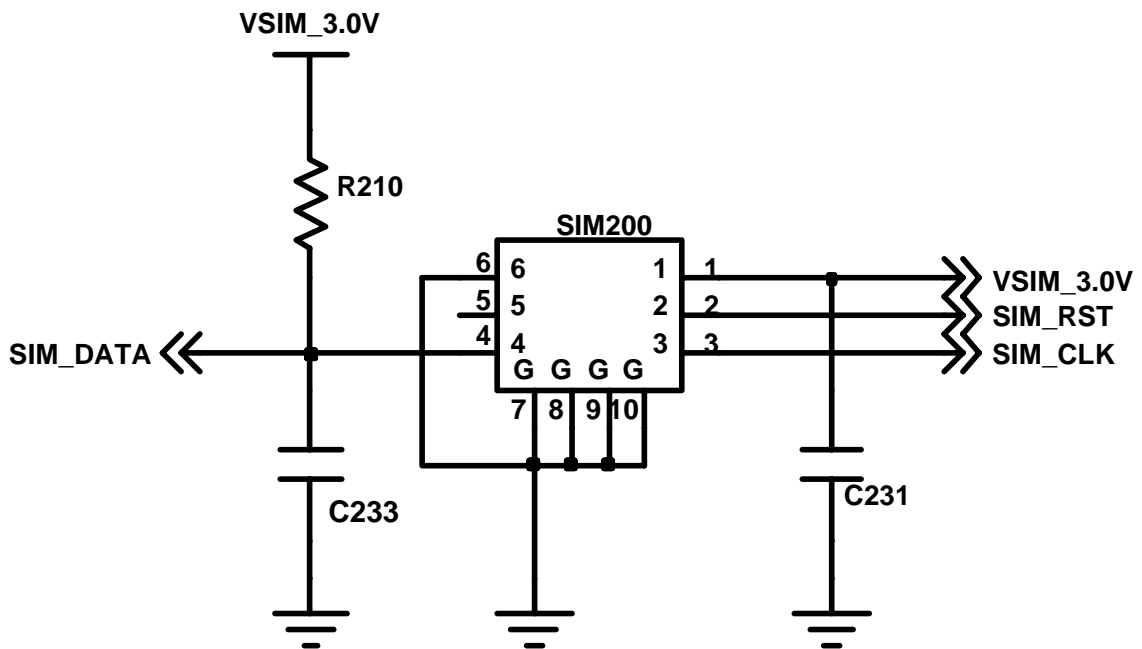
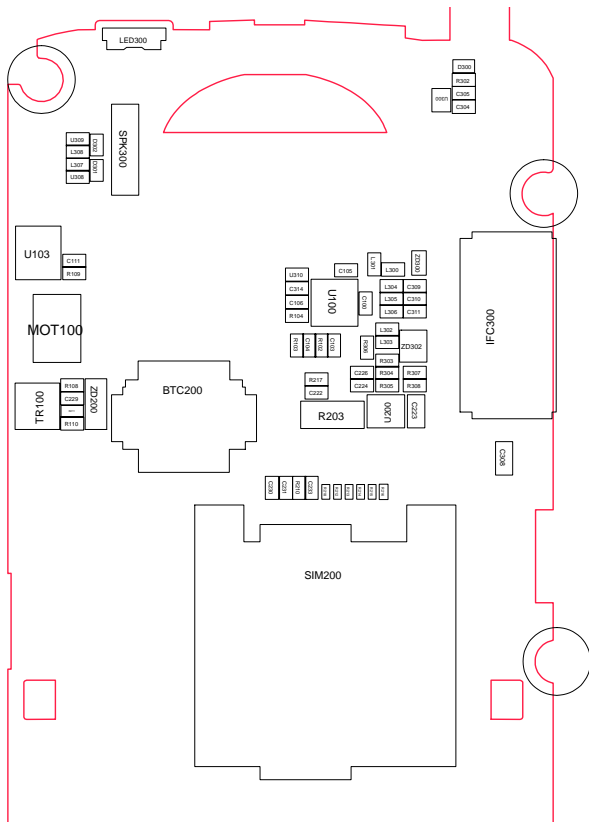

9-5. Microphone Part

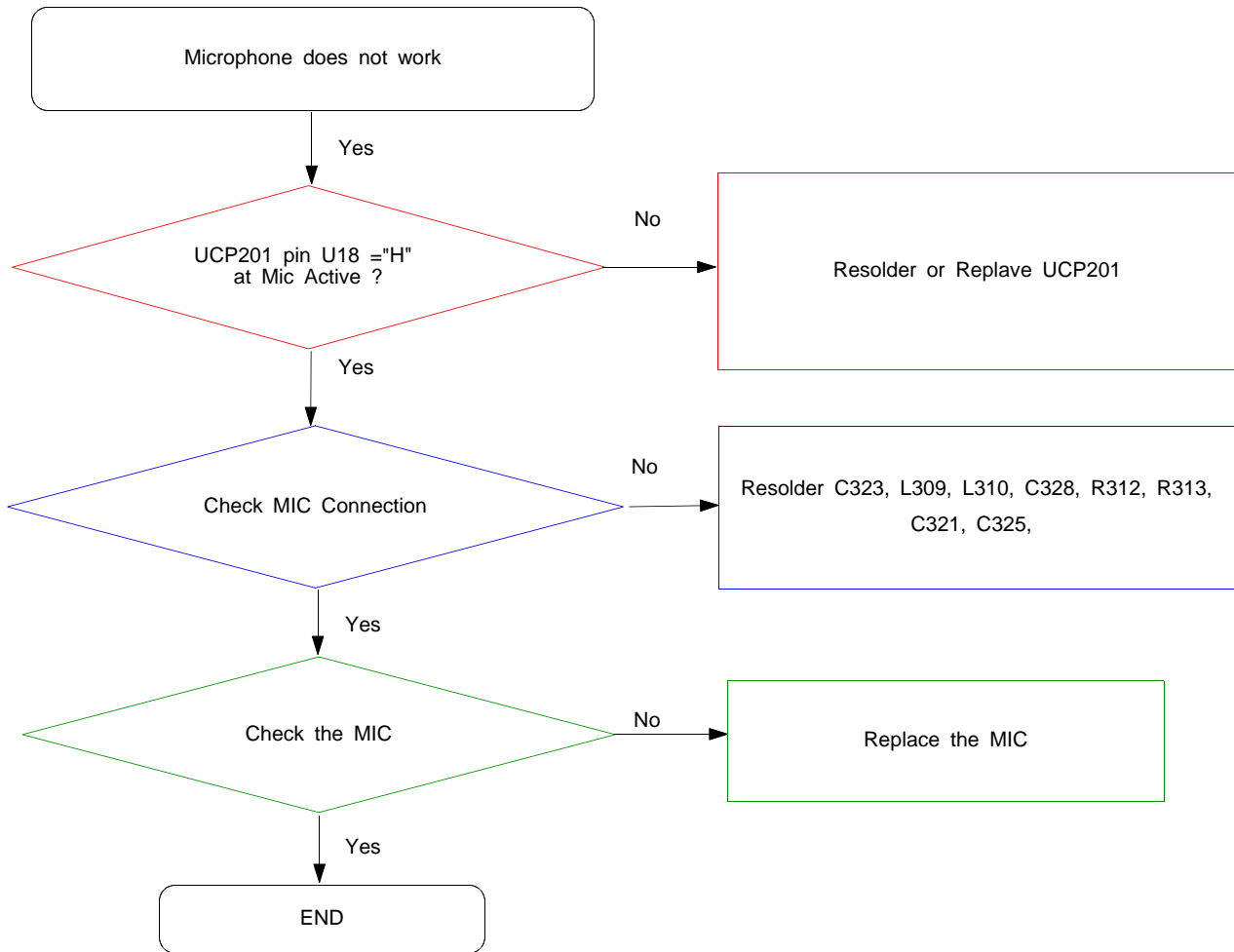

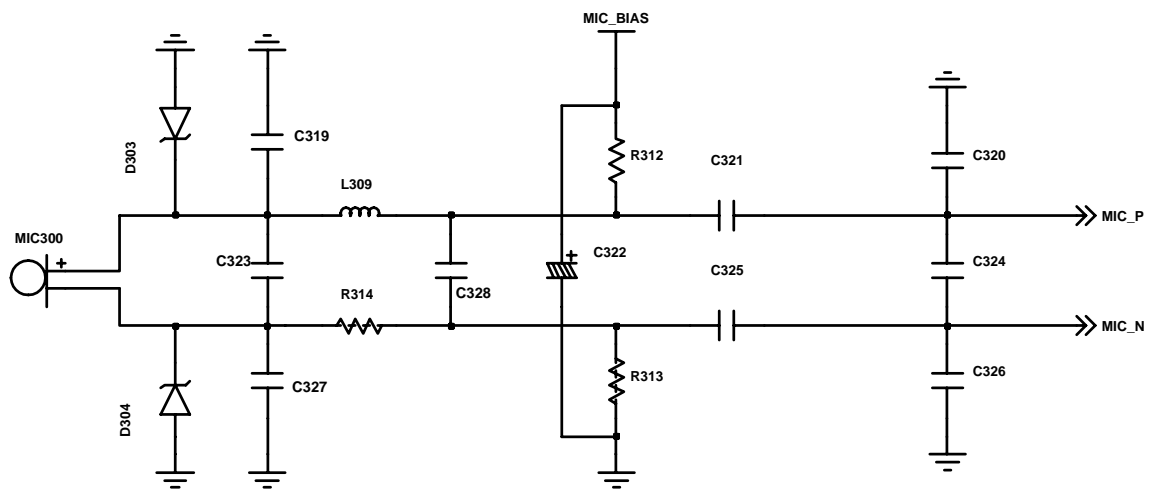
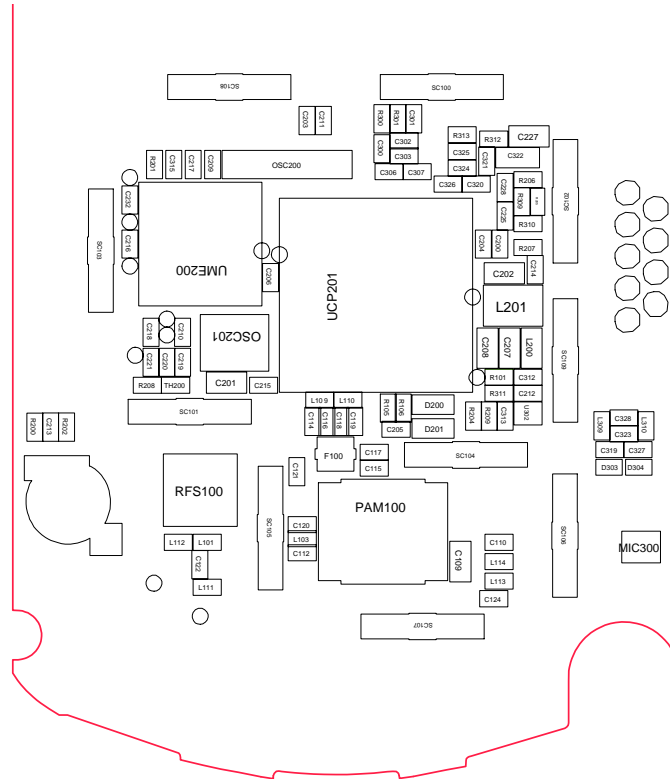

9-6. Speaker Part

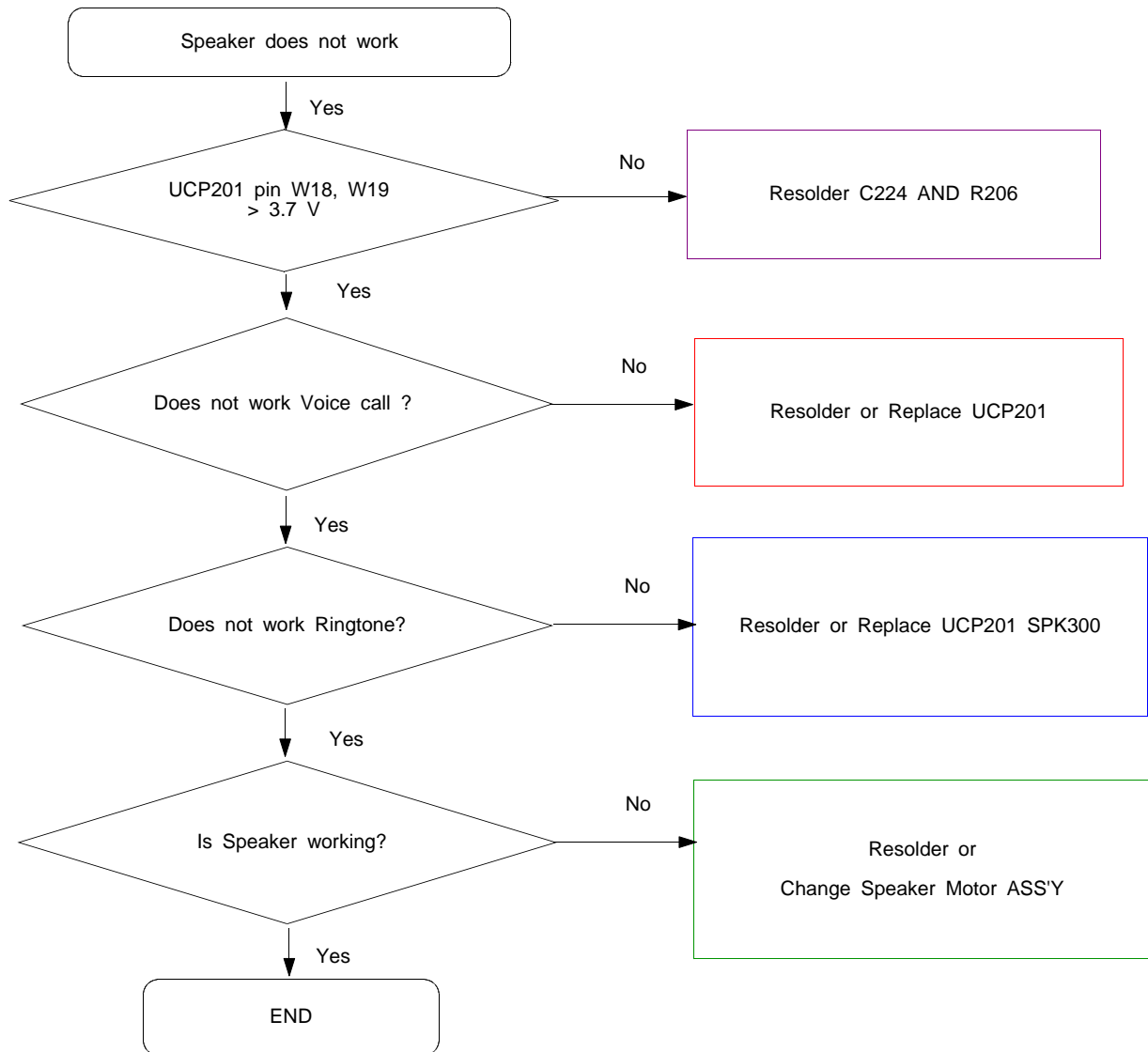

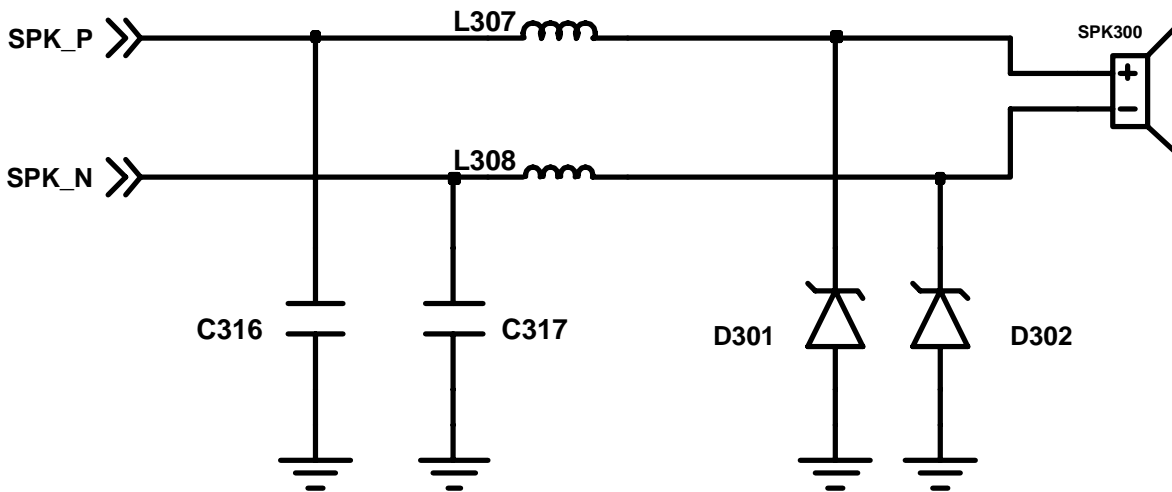
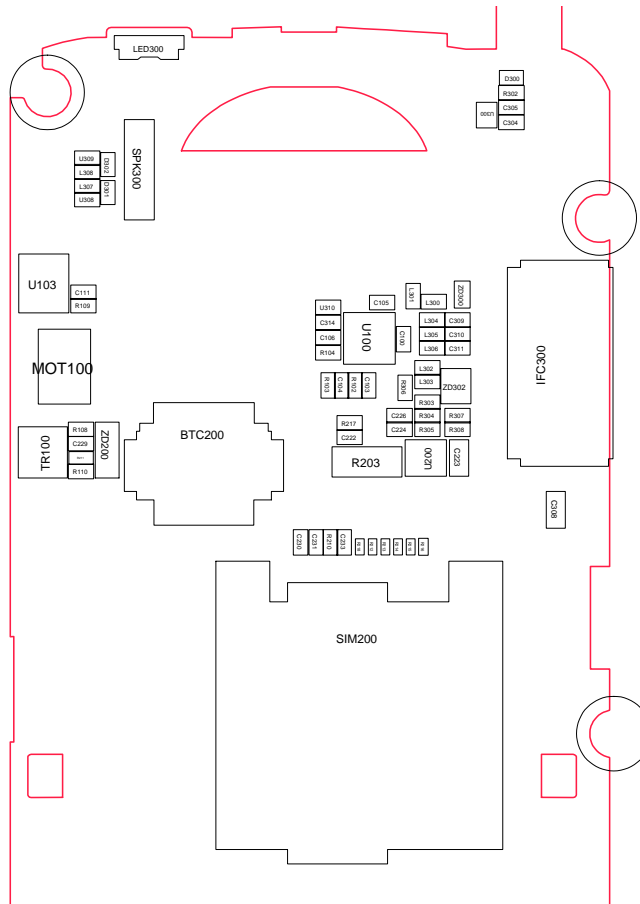

9-7. Key Data Input

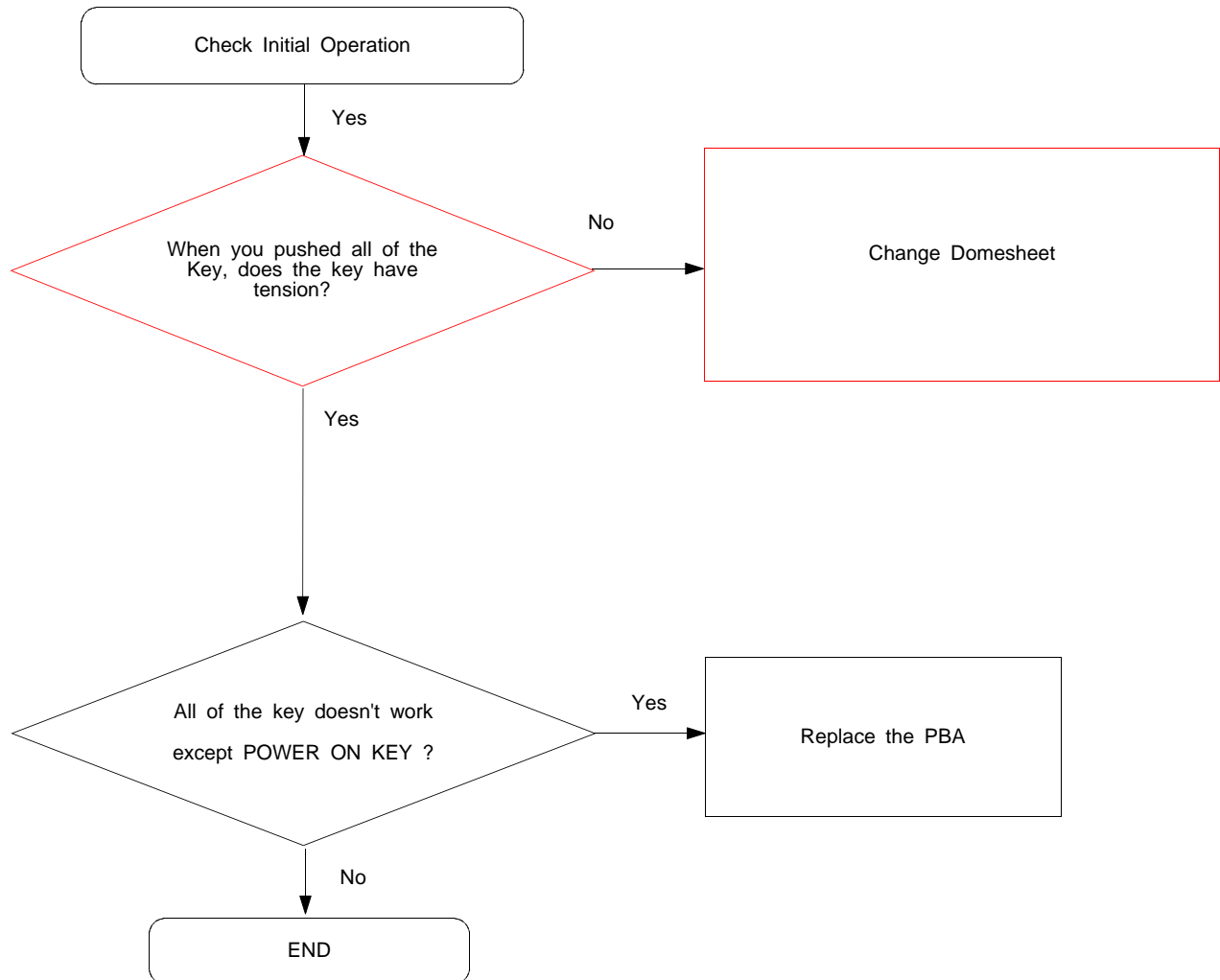

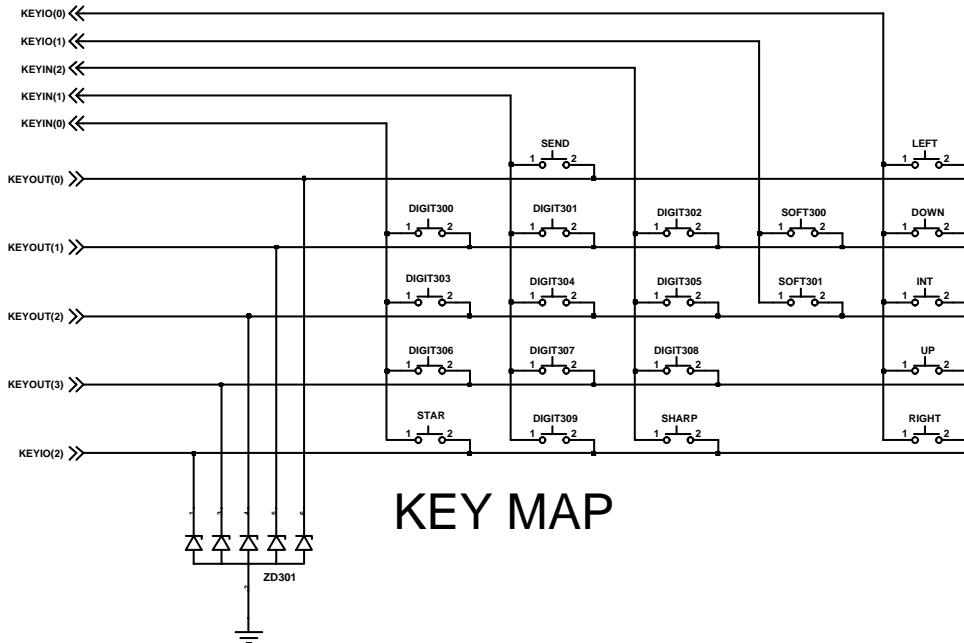
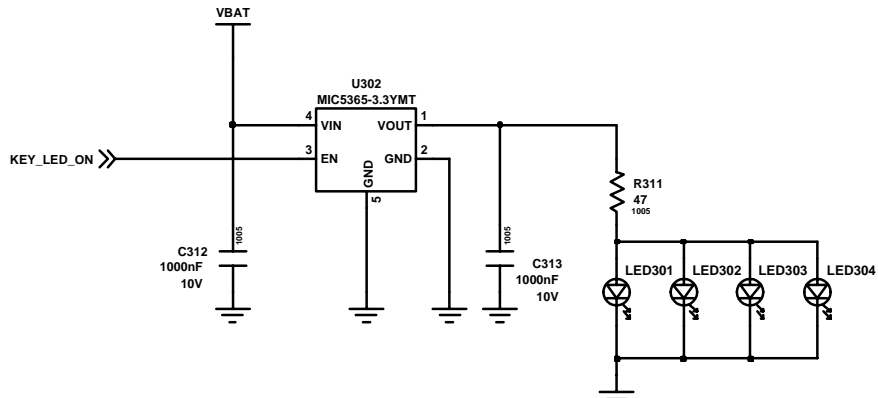
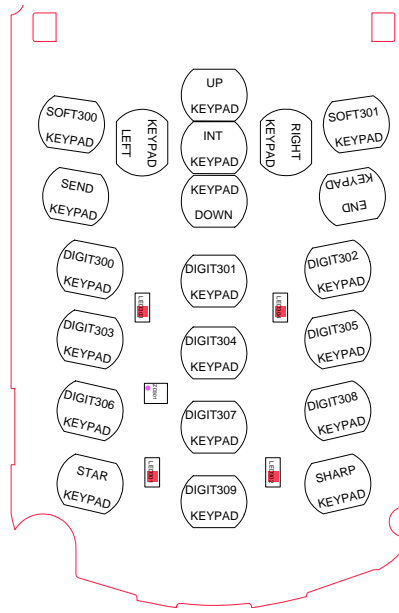

9-8. Back Light (for Color Main LCD)

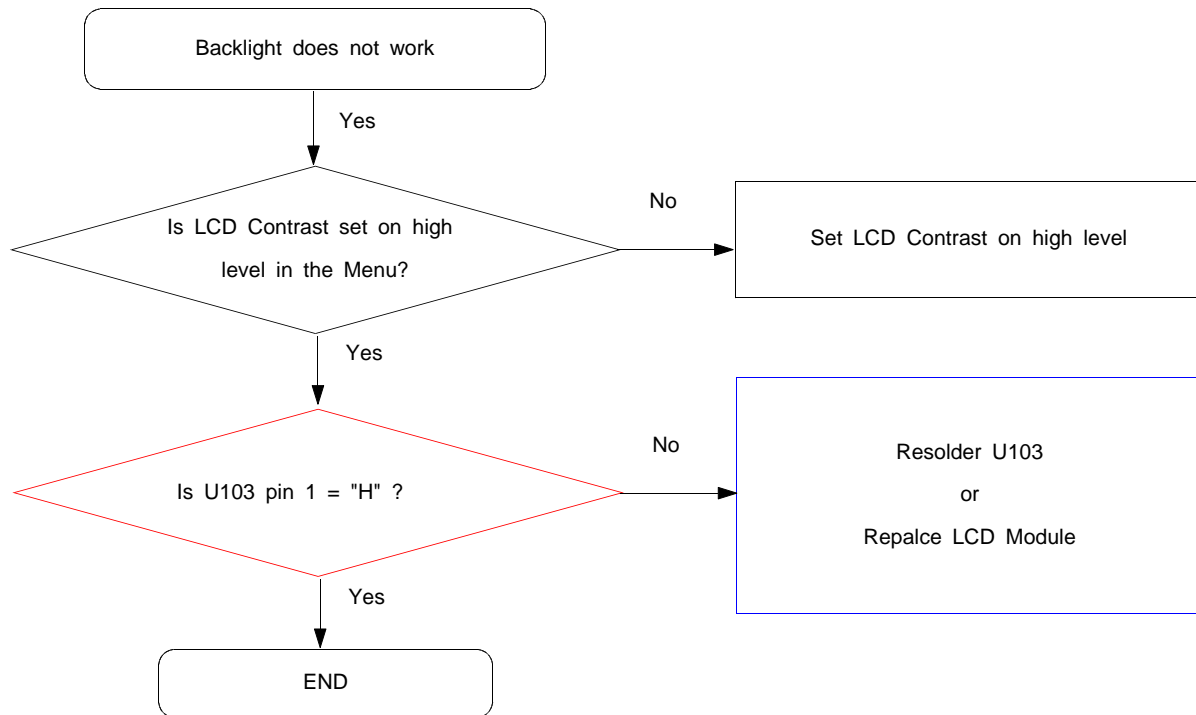

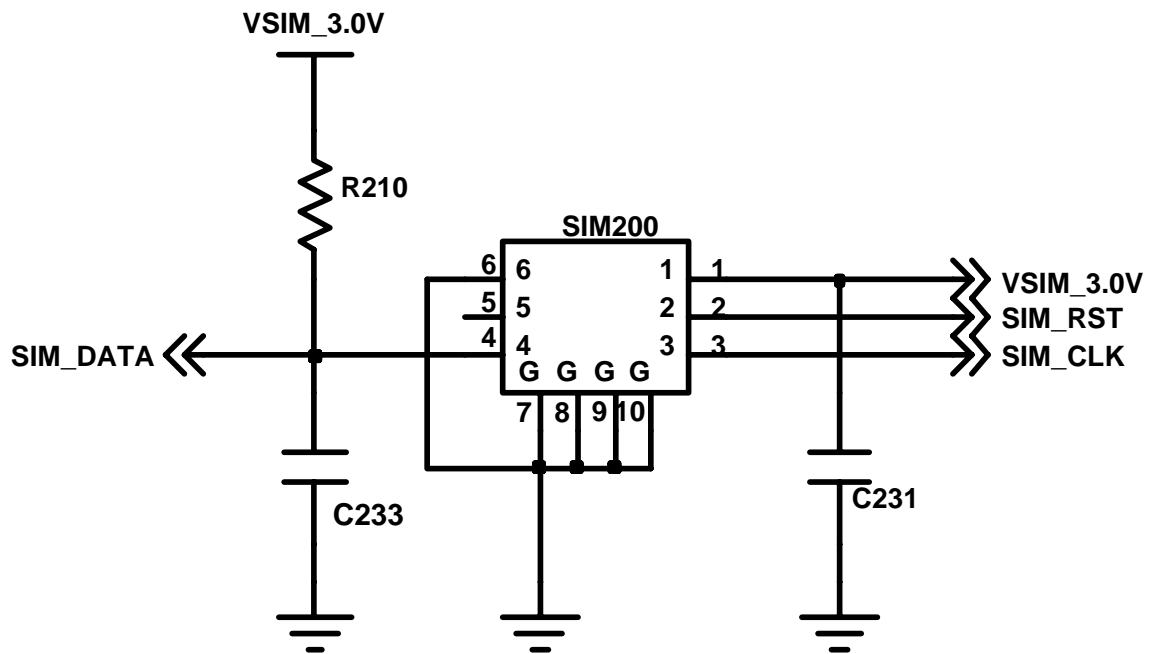
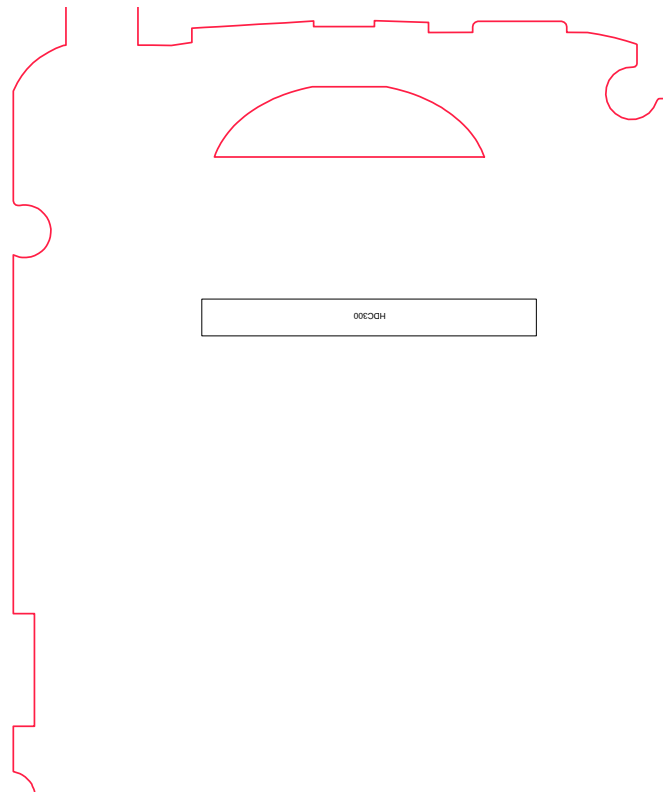

9-9. Key Back Light

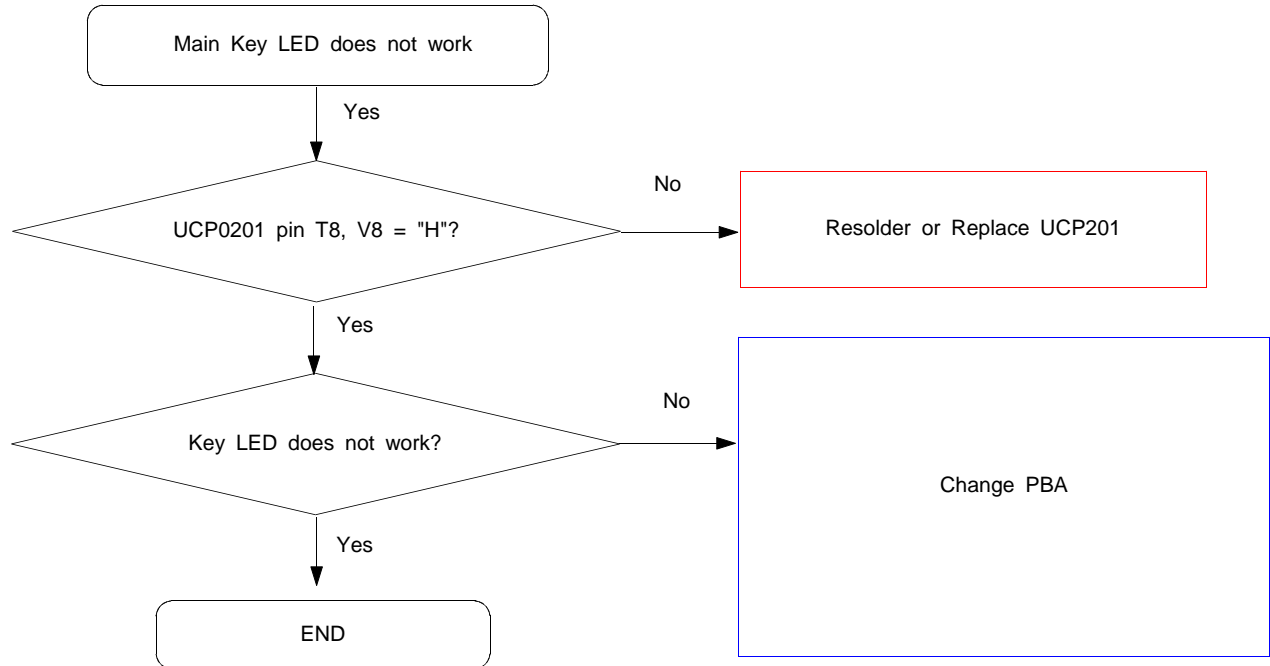

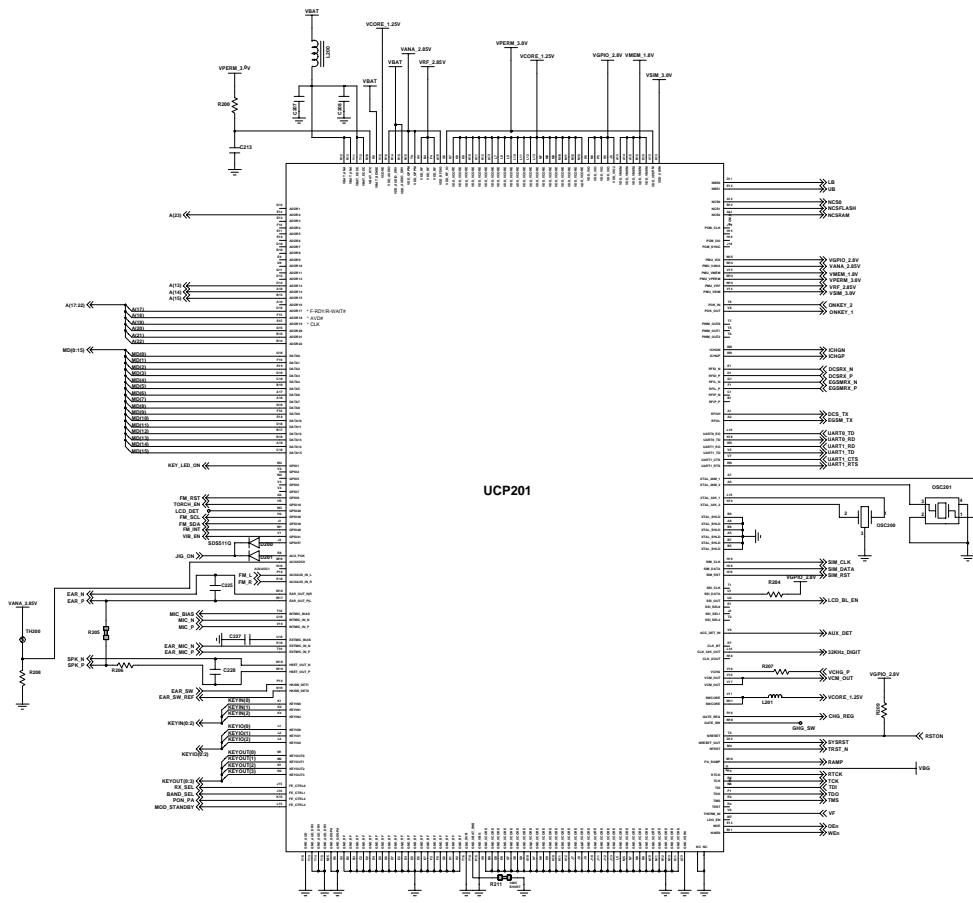
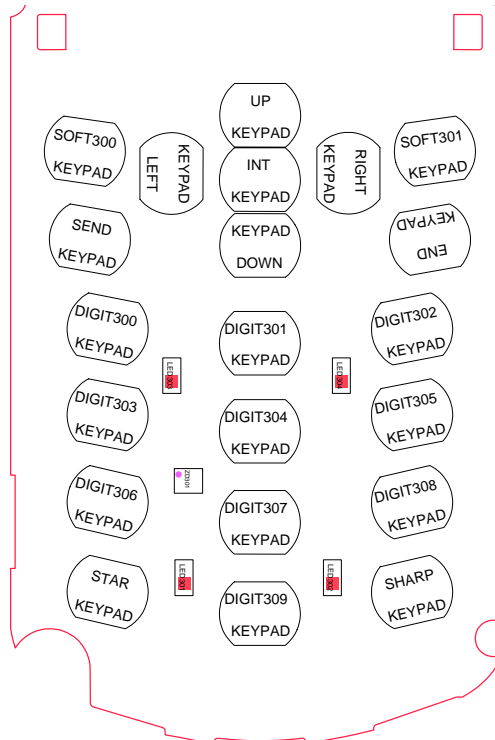

9-10. GSM900 Receiver

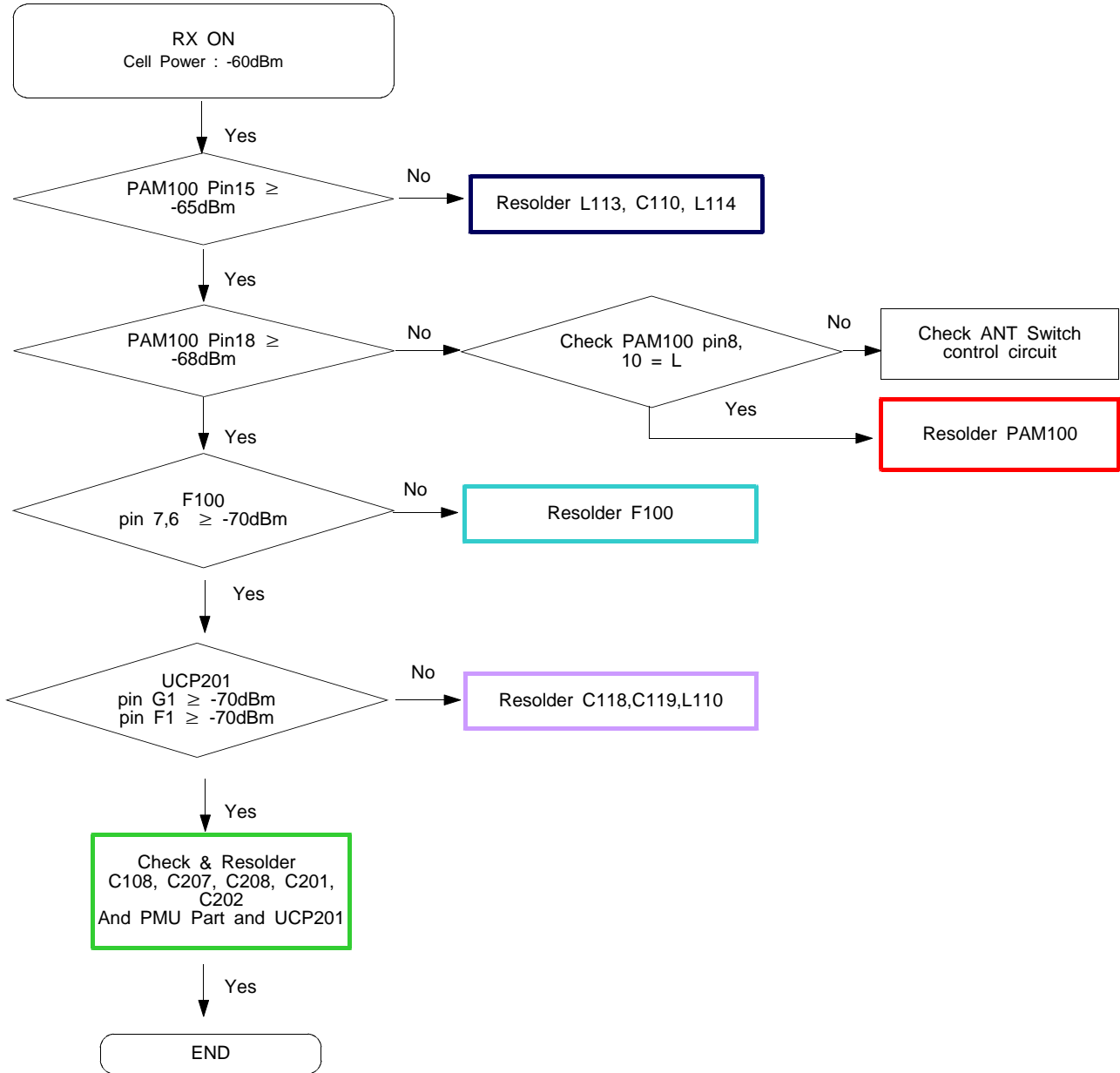

9-11. DCS Receiver

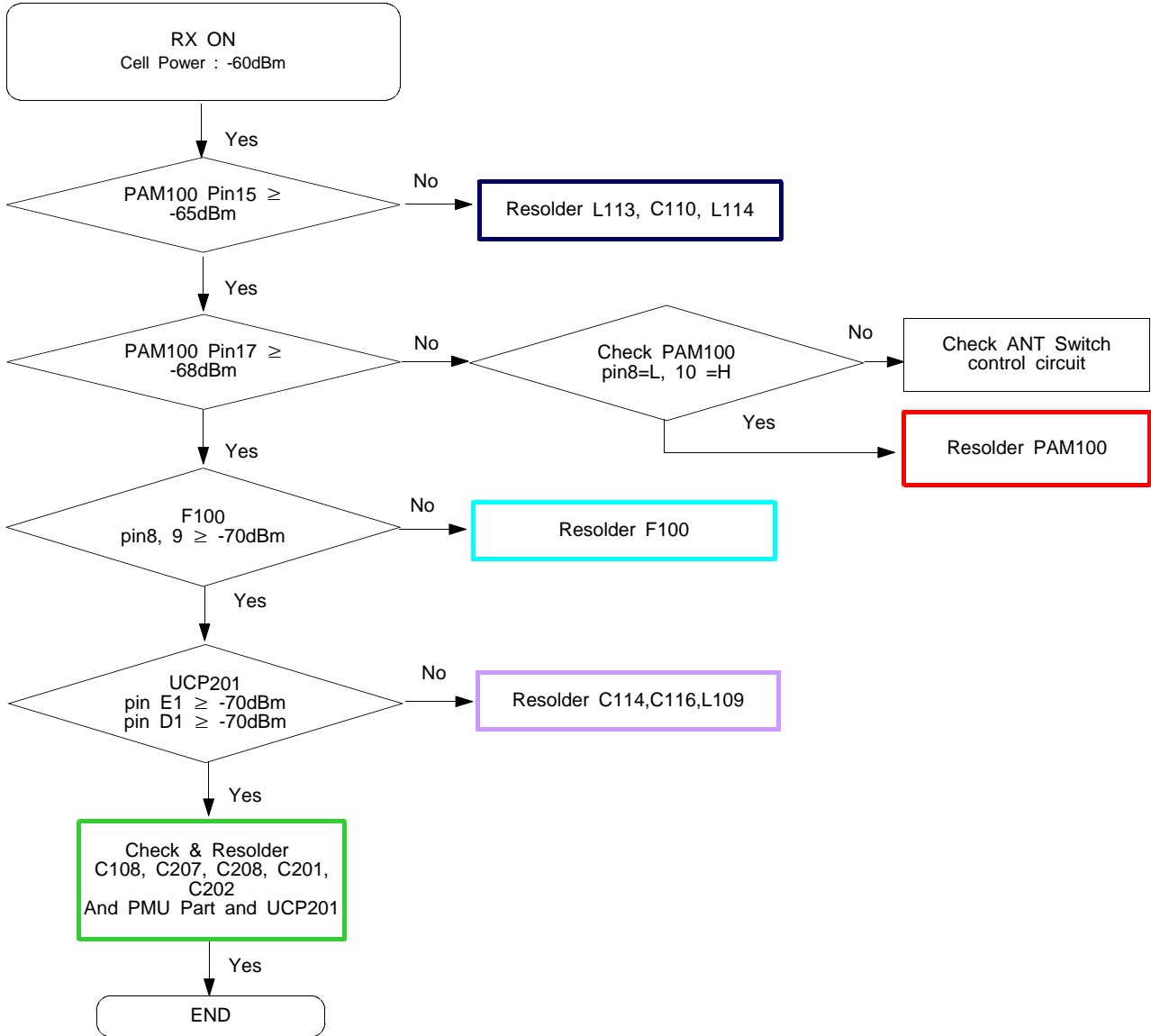

	MOD_STANBY	POW_PA	BIASD_SEL	RX_SEL
STANDBY	L	-	-	-
EGSM_RX	H	L	L	H
DCS_RX	H	L	H	H
EGSM_TX	H	H	L	-
DCS_TX	H	H	H	-

TX Module S/W Control Circuit

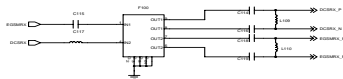
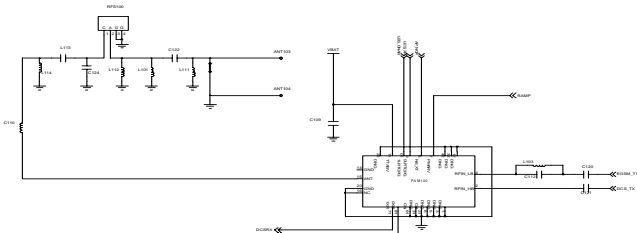

RF Part

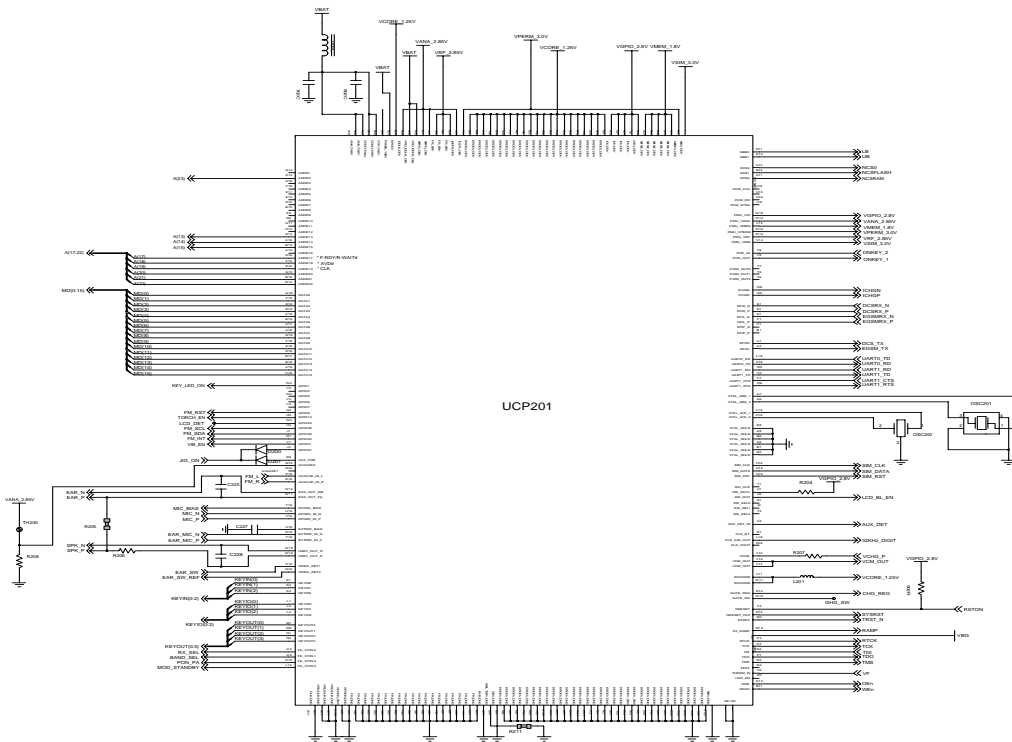

BASEBAND

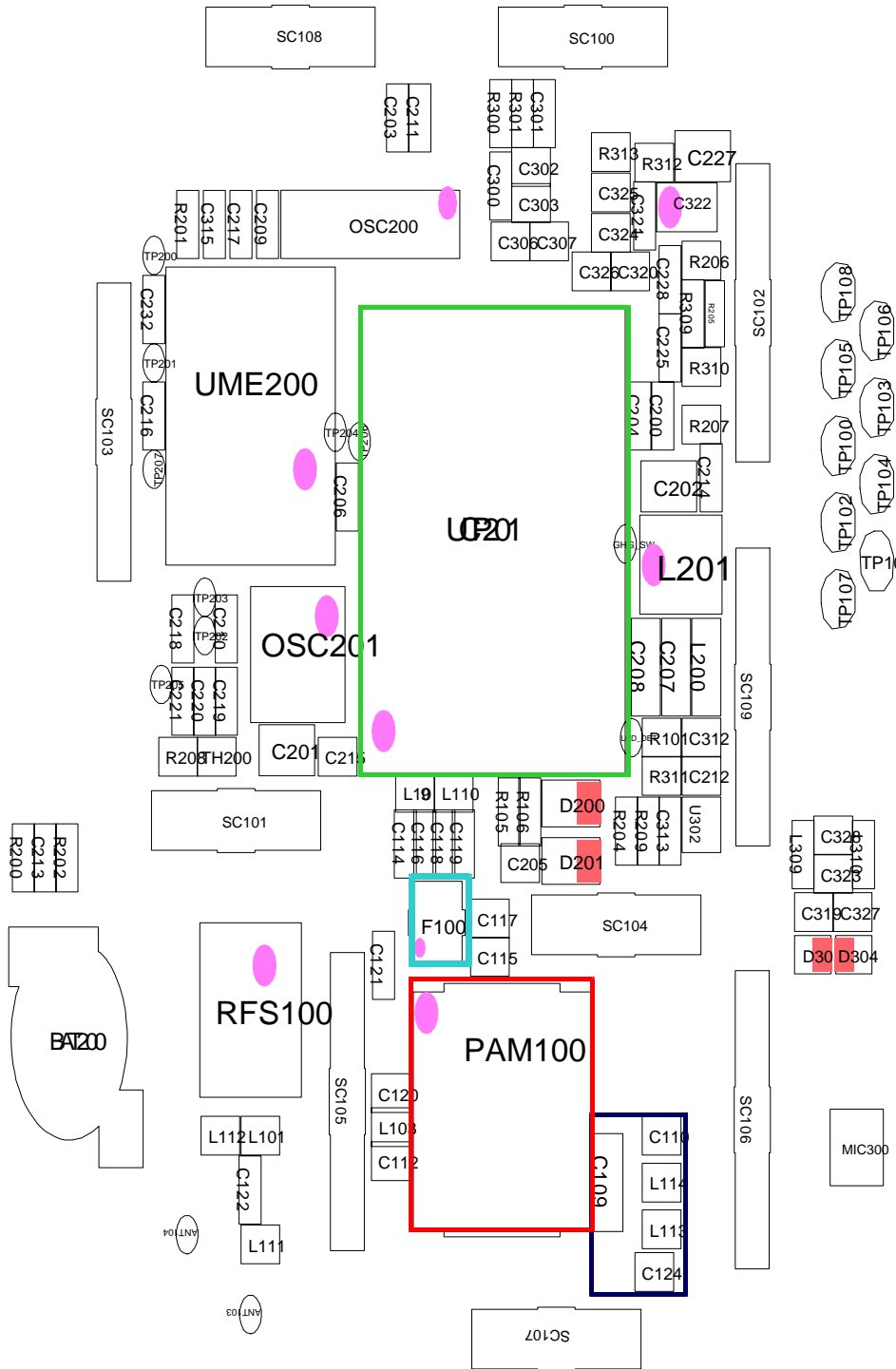

9-12. GSM900 Transmitter

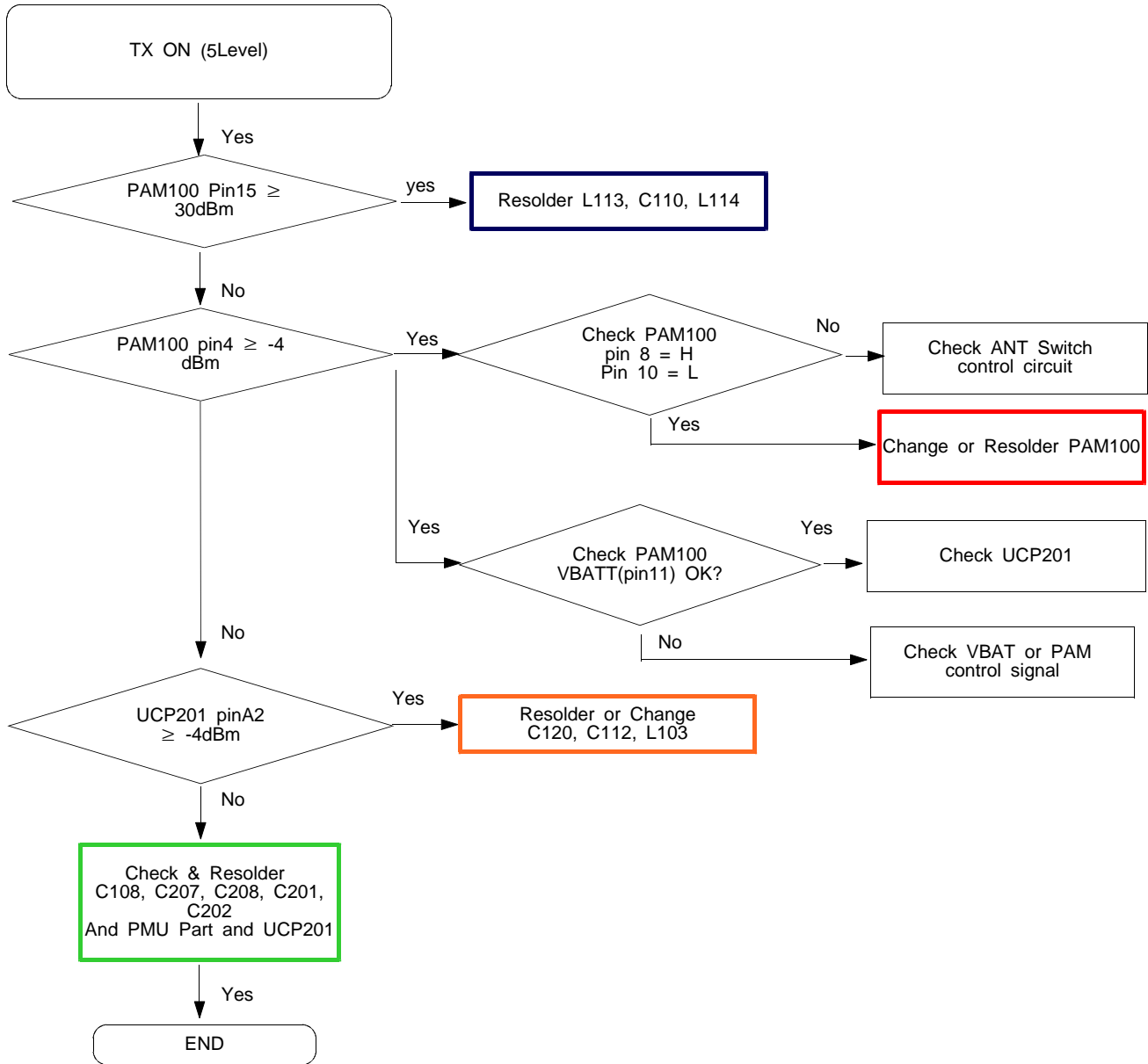

9-13. DCS Transmitter

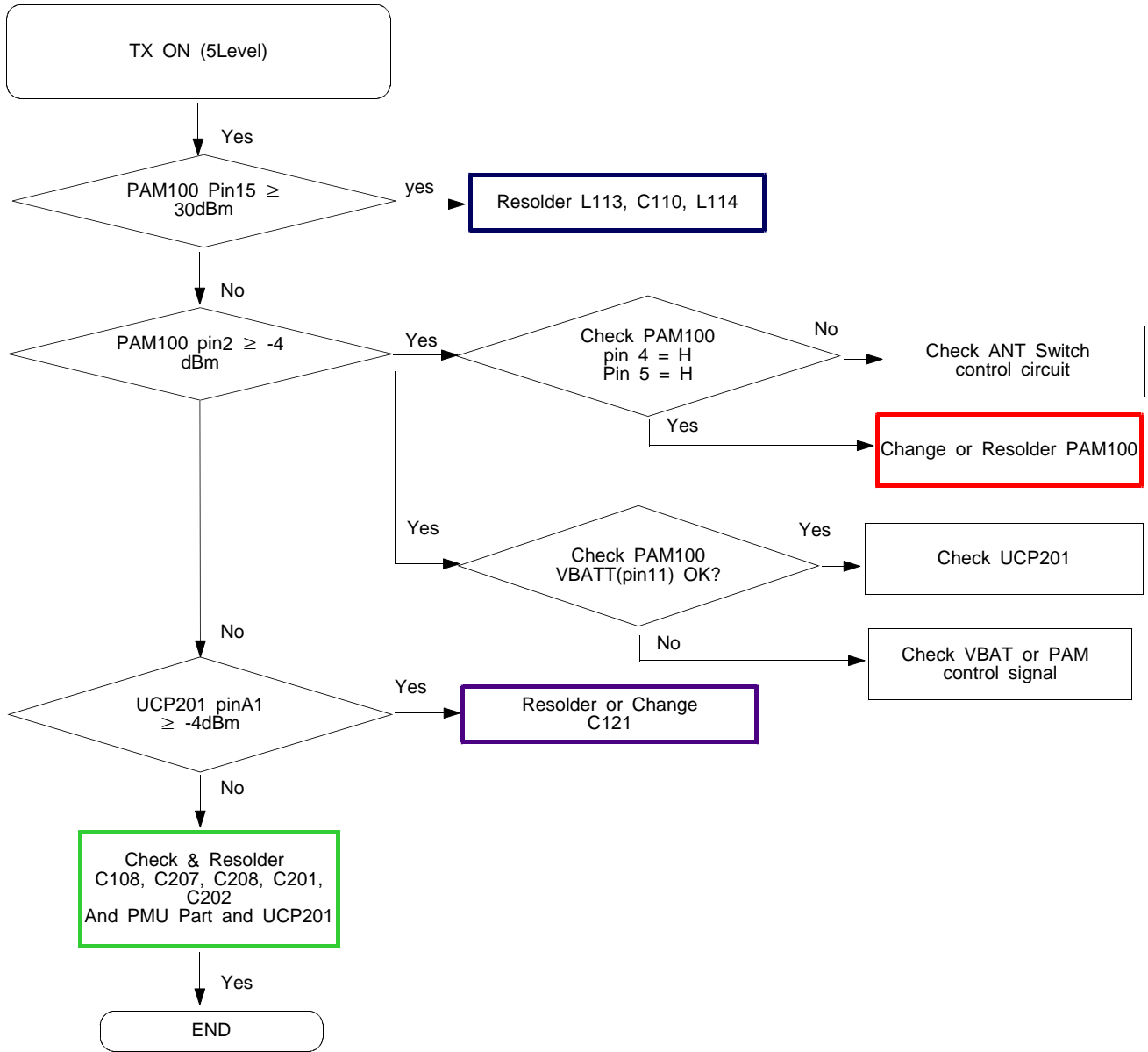

	MOD_STANDBY	FORM_PA	BAND_SEL	RIX_SEL
STAND_BY1	L	*	*	*
EGSM_RX	H	L	L	H
DCS_RX	H	L	H	H
EGSM_TX	H	H	L	-
DCS_TX	H	H	H	-

TX Module S/W Control Circuit

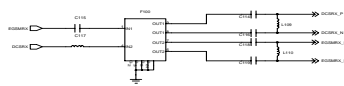
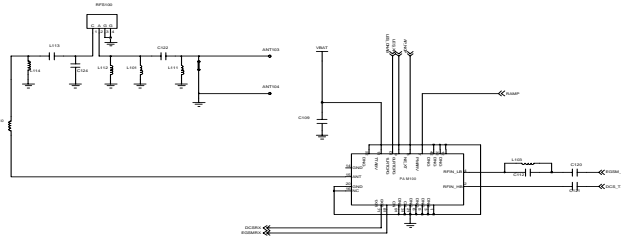

RF Part

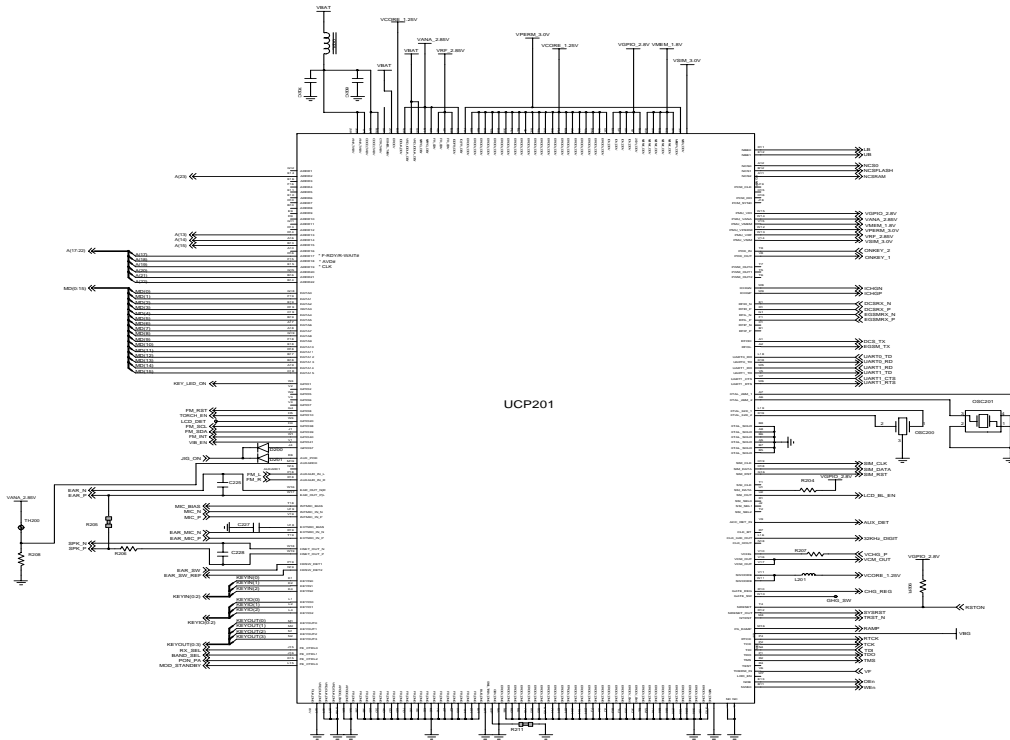

BASEBAND

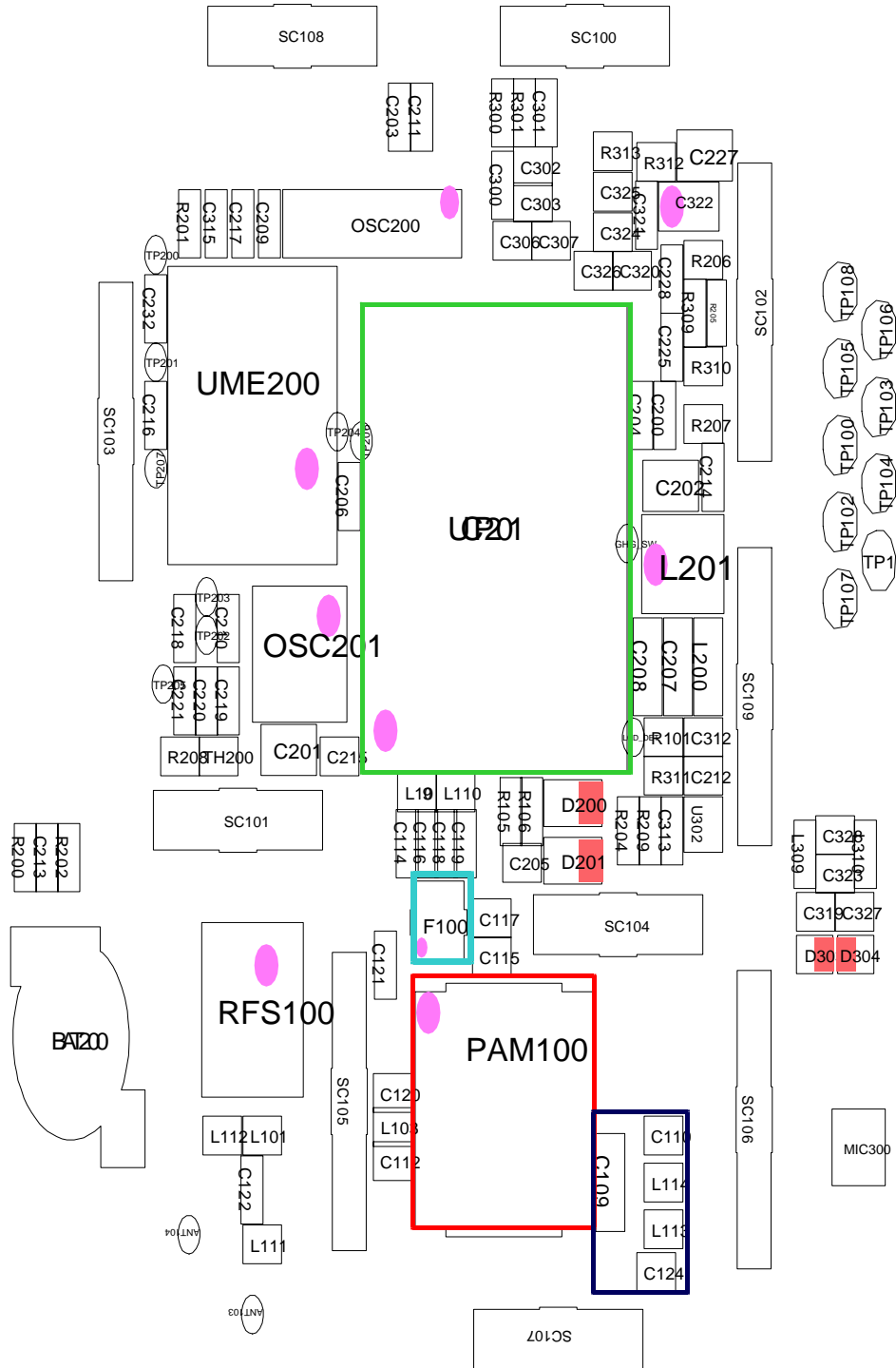

7. Block Diagrams

7-1. RF Block Diagram

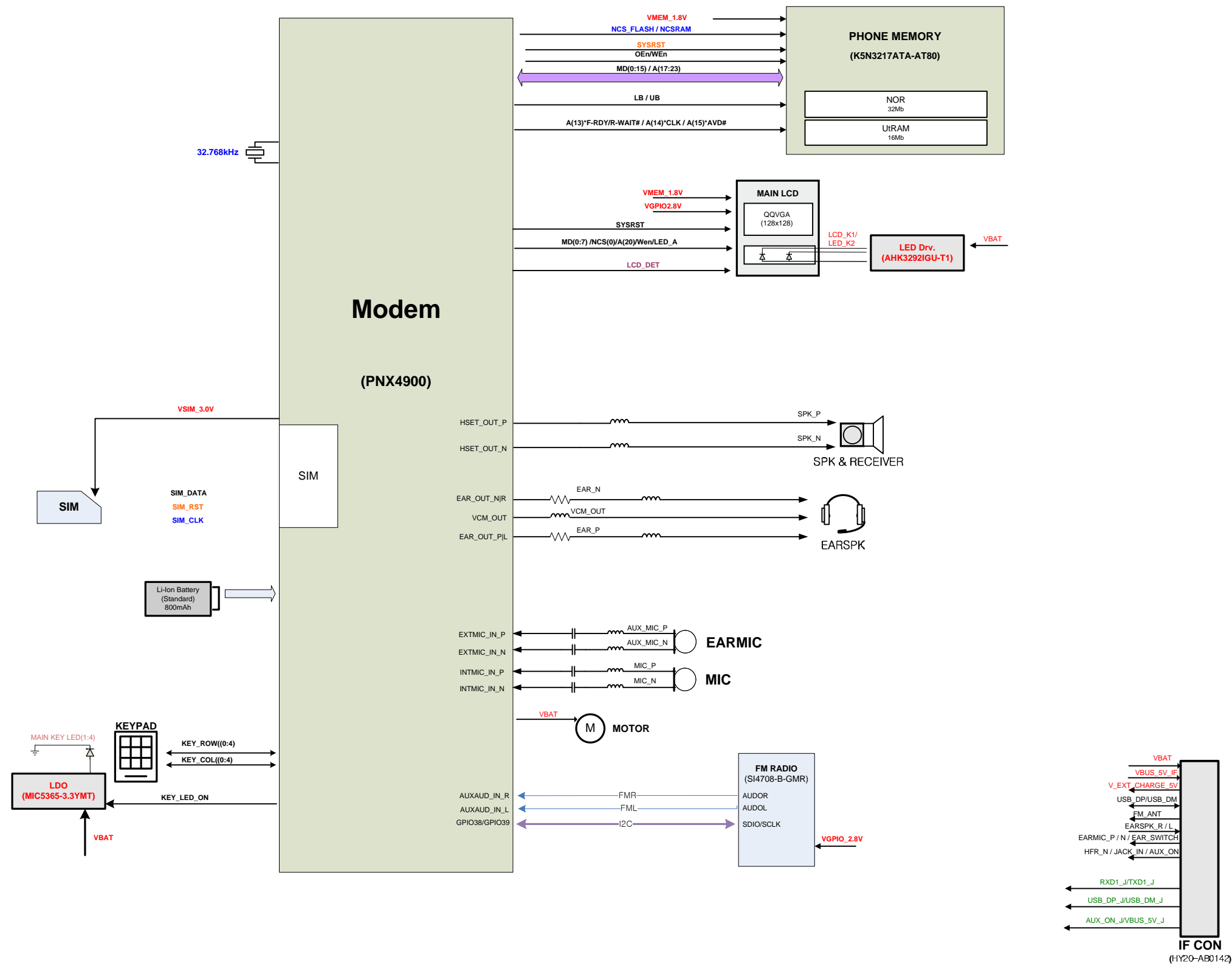

8. PCB Diagrams

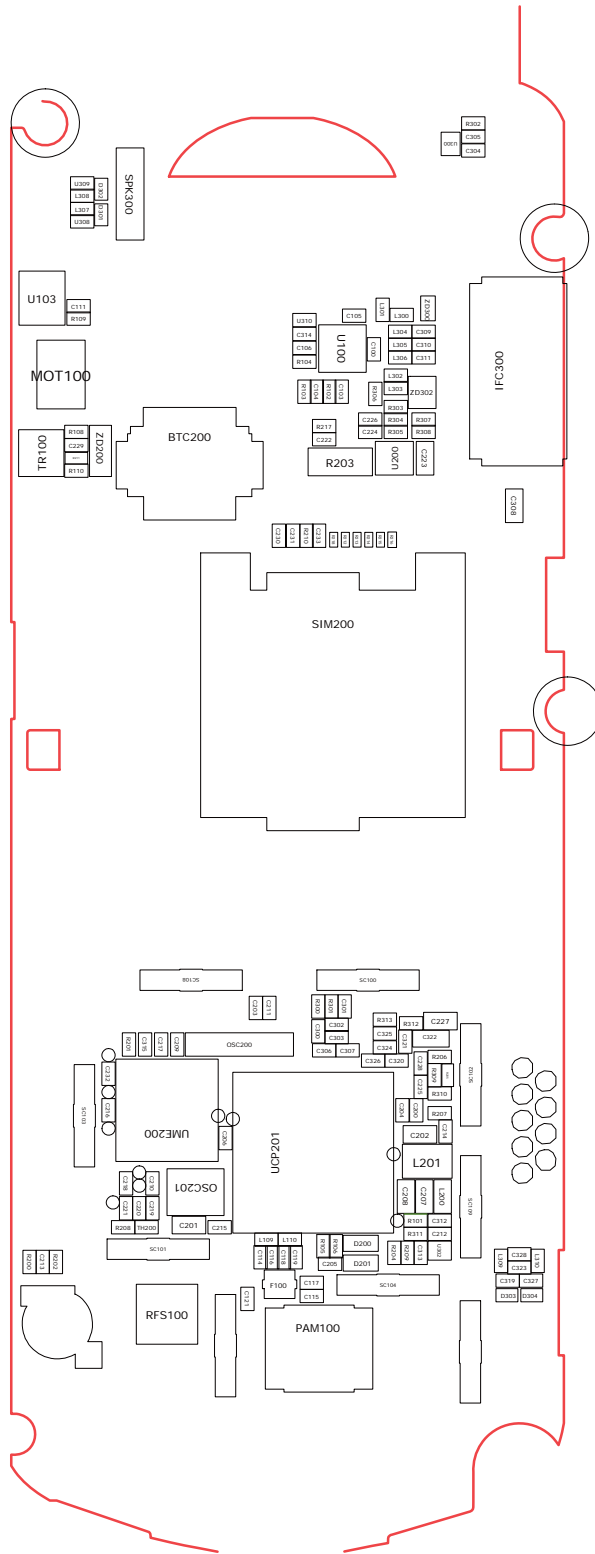

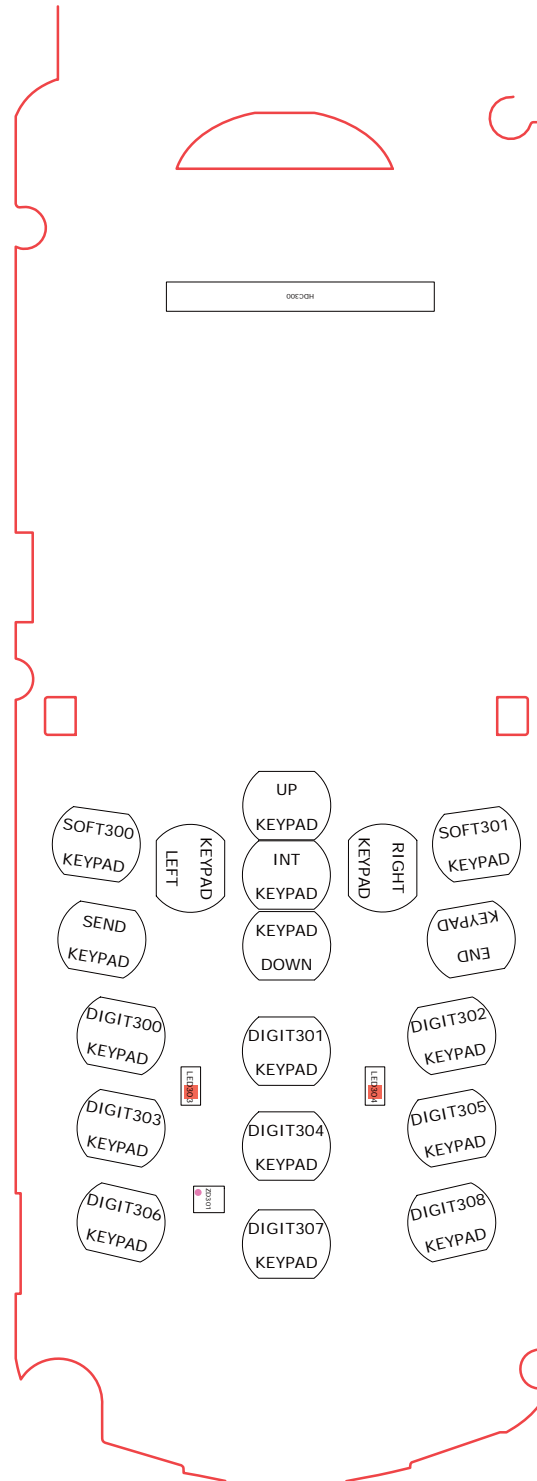

11. Disassembly and Assembly Instructions

11-1. Disassembly

1

Unscrew 3 points at the REAR case

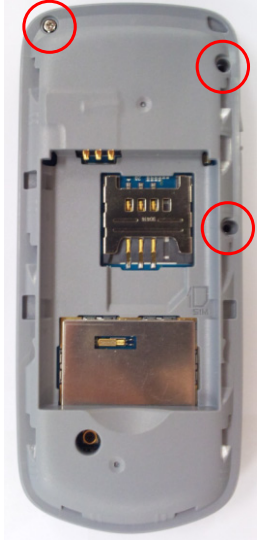

1) Be careful not to make scratch and molding damage!

2

Disassemble the REAR as below sequence

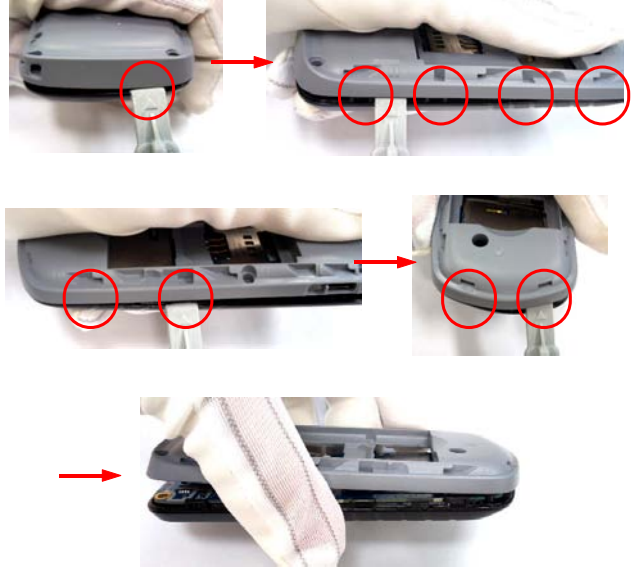

1) Be careful not to make scratch and molding damage!
2) Be careful not to damage IF COVER

3

Disassemble the PBA. Be careful with hooks.

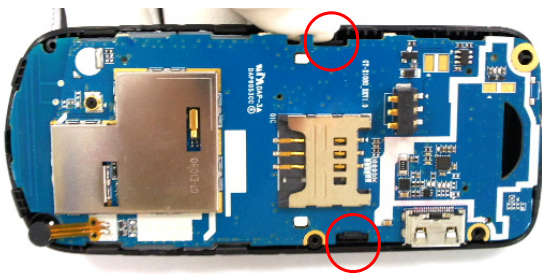

1) Be careful not to make scratch and molding damage!

4

Separate the PBA from the FRONT



1) Be careful not to make scratch and molding damage!

5 Push the hooks of both side of LCD

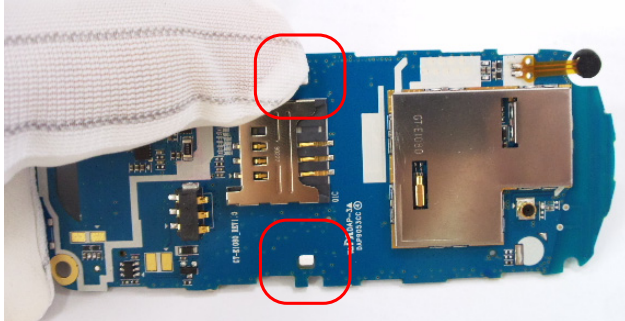

- 1) Be careful not to make scratch and molding damage!
- 2) Be careful not to damage LCD

6 Lift up bottom side of the LCD carefully.

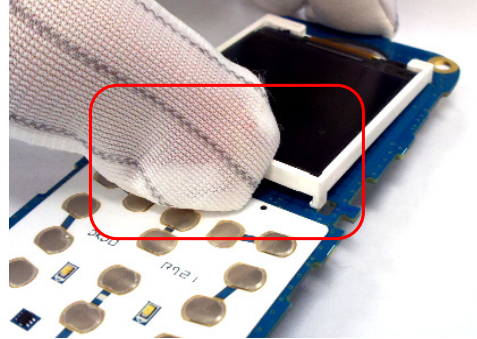

- 1) Be careful not to make scratch and molding damage!
- 2) Be careful not to damage LCD FPCB and LCD

7 Disassemble the LCD.

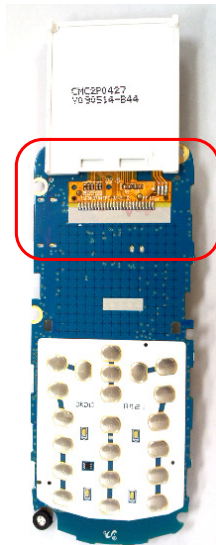

- 1) Be careful not to make scratch and molding damage!
- 2) Be careful not to damage LCD FPCB and LCD

8 Disassemble the SHIELD CAN

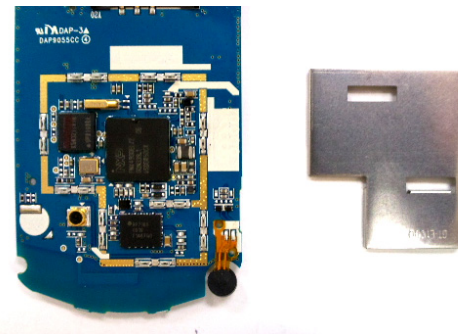

- 1) Be careful not to make scratch and molding damage!

9

Disassemble the MIC

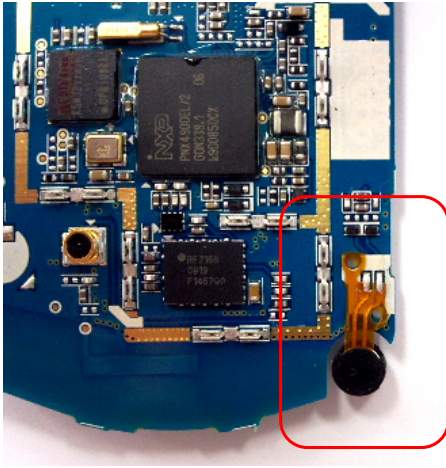

- 1) Be careful not to make scratch and molding damage!
- 2) Be careful not to damage MIC FPCB





10

Separate the KEYPAD from the FRONT

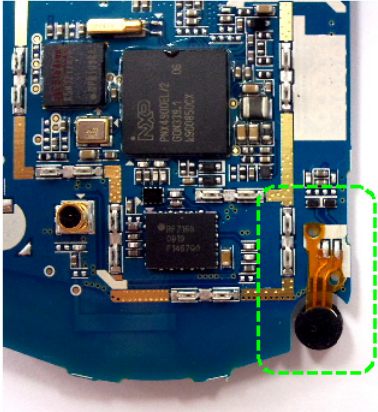

- 1) Be careful not to make scratch and molding damage!

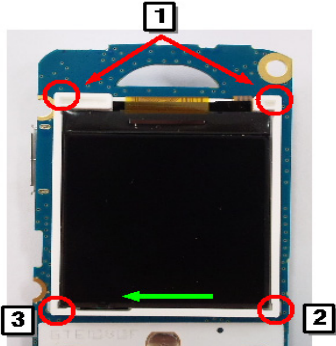
11-2. Assembly

<p>1 Soldering 2 points of MIC FPCB pad with PBA</p> 	<p>2 Soldering FPCB of the LCD MODULE</p> <p style="text-align: center;">CAUTION</p> <p style="text-align: center;">Check F-PCB to MAIN PCB soldering tightly. (If there is a gap between F-PCB and Main board will makes faulty)</p>  <p style="text-align: center;">Be careful not to make Flux on the Main Board (Use the cover of Soldering Jig)</p>
<p>1) Be careful not to make scratch and molding damage!</p>	<p>1) Be careful not to make scratch and molding damage! 2) Be careful not to make a gap between LCD FPCB and Main Board. 3) Height of solder should not over 0.2mm.</p>
<p>3 Combine LCD to Main Board.</p>  <p style="text-align: center;">Push LCD to left and make left hook takes it's position.</p> <p style="text-align: center;">CHECK POINT</p> <p>1. Order of LCD combining</p> <ol style="list-style-type: none"> ① Set LCD rib to it's hole ② Push and lock the hook which is at right-bottom side of LCD ③ Push and lock the hook which is at left-bottom side of LCD 	<p>4 Assemble the SHIELD CAN</p> 
<p>1) Be careful not to make scratch and molding damage! 2) Don't push the panel of LCD while combine the LCD</p>	<p>1) Be careful not to make scratch and molding damage!</p>

5 INSERT KEYPAD to FRONT.



1) Be careful not to make scratch and molding damage!

6 INSERT SPEAKER, MOTOR to REAR.

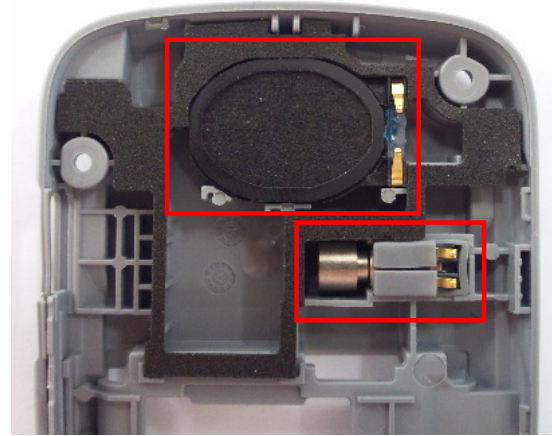

1) Be careful not to make scratch and molding damage!
 2) When insert MOTOR, use PUSHING JIG.
 3) CHECK SPEAKER, MOTOR insert tightly.

7 INSERT PBA TO FRONT.

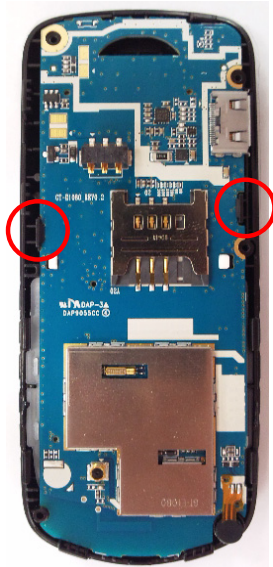

1) Be careful not to make scratch and molding damage!
 2) Be careful nothing goes between LCD and FRONT.

8 COMBINE REAR FROM TOP TO BOTTOM.

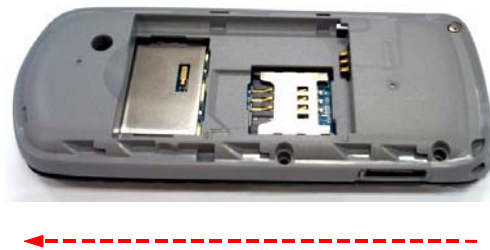

1) Be careful not to make scratch and molding damage!
 2) Be careful not to damage IF COVER.

9

Screw 3 points at the REAR case.

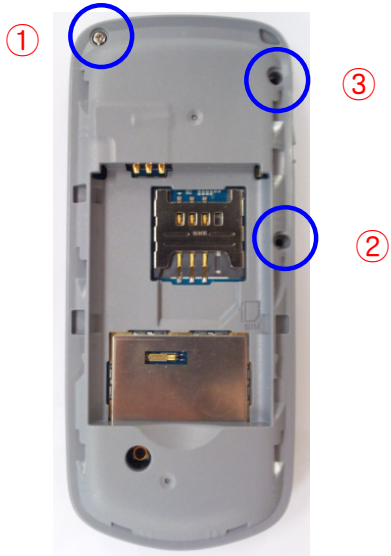

1) Be careful not to make scratch and molding damage!